



SERVICE MANUAL

BA-6 CHASSIS

<u>MODEL NAME</u>	<u>REMOTE COMMANDER</u>	<u>DESTINATION</u>	<u>CHASSIS NO.</u>
 KV-27FA310	RM-Y180	US	SCC-S61U-A
 KV-27FA310	RM-Y180	CANADA	SCC-S59Q-A
KV-27FS120	RM-Y195	US	SCC-S61N-A
KV-27FS120	RM-Y195	CANADA	SCC-S59J-A
KV-29FA310	RM-Y180	LATIN NORTH	SCC-S60V-A
KV-29FA310	RM-Y180	LATIN SOUTH	SCC-S60W-A
KV-29FS120	RM-Y195	LATIN NORTH	SCC-S73D-A
KV-29FS120	RM-Y195	LATIN SOUTH	SCC-S73E-A

ORIGINAL MANUAL ISSUE DATE: 3/2004

 :UPDATED ITEM

<u>REVISION DATE</u>	<u>SUBJECT</u>
3/2004	No revisions or updates are applicable at this time.
8/2004	Reissue entire manual Added KV-27FA310 model for US and Canada
7/2005	Updated A Board Schematic to correct Y signal. Replaced Page 38

TRINITRON® COLOR TELEVISION
SONY®

SERVICE MANUAL

BA-6 CHASSIS

<u>MODEL NAME</u>	<u>REMOTE COMMANDER</u>	<u>DESTINATION</u>	<u>CHASSIS NO.</u>
☛ KV-27FA310	RM-Y180	US	SCC-S61U-A
☛ KV-27FA310	RM-Y180	CANADA	SCC-S59Q-A
KV-27FS120	RM-Y195	US	SCC-S61N-A
KV-27FS120	RM-Y195	CANADA	SCC-S59J-A
KV-29FA310	RM-Y180	LATIN NORTH	SCC-S60V-A
KV-29FA310	RM-Y180	LATIN SOUTH	SCC-S60W-A
KV-29FS120	RM-Y195	LATIN NORTH	SCC-S73D-A
KV-29FS120	RM-Y195	LATIN SOUTH	SCC-S73E-A



KV-27FS120



KV-29FA310

TRINITRON® COLOR TELEVISION

SONY®

TABLE OF CONTENTS

SECTION TITLE	PAGE
Specifications	4
Warnings and Cautions	5
Safety Check-Out	6
Self-Diagnostic Function.....	7
SECTION 1: DISASSEMBLY.....	9
1-1. Rear Cover Removal (All Except KV-27FA310/29FA310).....	9
1-2. Rear Cover Removal (KV-27FA310/29FA310 Only)	9
1-3. Chassis Assembly Removal (All Except KV-27FA310/29FA310).....	10
1-4. Chassis Assembly Removal (KV-27FA310/29FA310 Only)	10
1-5. Service Position (All Except KV-27FA310/29FA310)	11
1-6. Service Position (KV-27FA310/29FA310 Only)	11
1-7. Picture Tube Removal.....	12
Anode Cap Removal Procedure.....	12
SECTION 2: SET-UP ADJUSTMENTS.....	13
2-1. Beam Landing	13
2-2. Convergence.....	14
2-3. Focus	15
2-4. Screen (G2).....	16
2-5. Method of Setting the Service Adjustment Mode	16
2-6. White Balance Adjustments	16
SECTION 3: SAFETY RELATED ADJUSTMENTS.....	17
3-1. <input checked="" type="checkbox"/> R564 Confirmation Method (HV Hold-Down Confirmation) and Readjustments	17
3-2. B+ Voltage Confirmation and Adjustment	17
SECTION 4: CIRCUIT ADJUSTMENTS.....	19
4-1. Setting the Service Adjustment Mode	19
4-2. Memory Write Confirmation Method	19
4-3. Remote Adjustment Buttons and Indicators	19
4-4. Service Data Lists	20
4-5. ID Map Table	32
4-6. A Board Adjustments.....	32
SECTION 5: DIAGRAMS.....	35
5-1. Circuit Boards Location	35
5-2. Printed Wiring Board and Schematic Diagram Information.....	35
5.3. Block Diagram and Schematics	37
A Board Schematic Diagram	38
CW Board Schematic Diagram	40
D Board Schematic Diagram (All Except KV-27FA310/29FA310)	41
HS Board Schematic Diagram(All Except KV-27FA310/29FA310)	42
V Board Schematic Diagram	42
GD Board Schematic Diagram (KV-27FA310/29FA310 Only)	45
HR Board Schematic Diagram (KV-27FA310/29FA310 Only).....	48
HU Board Schematic Diagram (KV-27FA310/29FA310 Only).....	50
K Board Schematic Diagram (KV-27FA310/29FA310 Only)	53
5-4. Semiconductors	54
SECTION 6: EXPLODED VIEWS.....	55
6-1. Picture Tube (KV-27FS120/29FS120 Only)	55
6-2. Chassis (KV-27FS120/29FS120 Only).....	56
6-3. Picture Tube (KV-27FA310/29FA310 Only).....	57
6-4. Chassis (KV-27FA310/29FA310 Only).....	58
SECTION 7: ELECTRICAL PARTS LIST.....	59

SPECIFICATIONS

	KV-27FS120	KV-29FS120 (L. NORTH)	KV-29FS120 (L. SOUTH)	KV-27FA310 & KV-29FA320 (L. NORTH)	KV-29FA320 (L. SOUTH)
Power Requirements	120V, 60Hz		220V, 50/60Hz	120V, 60Hz	220V, 50/60Hz
Number of Inputs/Outputs					
Video ¹⁾	3			3	
S Video ²⁾	1			1	
Y, P_B, P_R ³⁾	1			1	
Audio ⁴⁾	2			2	
Speaker Output (W)	10W x 2			7W x 3	
Subwoofer	N/A			20W	
Power Consumption (W)					
In Use (Max)	180W		175W	220W	215W
In Standby (Max) ⁵⁾	1W		1W	1W	1W
Dimensions (W x H x D)					
mm	768 x 589 x 497 mm			784 x 678 x 520.5 mm	
in	30 ^{1/4} x 23 ^{1/4} x 19 ^{5/8} in			30 ^{7/8} x 26 ^{3/4} x 20 ^{1/2} in	
Mass					
kg	45.2 kg			50 kg	
lbs	99 lbs 10 oz			110 lbs 4 oz	

Television system

American TV standard, NTSC

Channel coverage

VHF: 2-13/ UHF: 14-69/ CATV: 1-125

Picture tube

FD Trinitron[®] tube

Visible screen size

27-inch picture measured diagonally

Actual screen size

29-inch measured diagonally

Supplied Accessories

Remote Commander RM-Y195
(All Except KV-27FA310/29FA310 Only)
Remote Commander RM-Y180
(KV-27FA310/29FA310 Only)
Two Size AA (R6) Batteries

- 1) 1 Vp-p 75 ohms unbalanced, sync negative
- 2) Y: 1 Vp-p 75 ohms unbalanced, sync negative
C: 0.286 Vp-p (Burst signal), 75 ohms
- 3) Y: 1.0 Vp-p, 75 ohms, sync negative; PB: 0.7 Vp-p, 75 ohms;
PR Vp-p, 75 ohms.
- 4) 500 mVrms (100% modulation), Impedance: 47 kilohms
- 5) This specification is the maximum wattage.

TruSurround™
by SRS (●)®

TruSurround is a trademark of SRS Labs, Inc. SRS and the SRS symbol are registered trademarks of SRS Labs, Inc. in the United States and in select foreign countries. SRS and TruSurround are incorporated under license from SRS Labs, Inc. and are protected under United States Patent Nos. 4,748,669 and 4,841,572 with numerous additional issued and pending foreign patents. Purchase of this product does not convey the right to sell recordings made with the TruSurround technology.

● SRS (SOUND RETRIEVAL SYSTEM)

The ● SRS (SOUND RETRIEVAL SYSTEM) is manufactured by Sony Corporation under license from SRS Labs, Inc. It is covered by U.S. Patent No. 4,748,669. Other U.S. and foreign patents pending.

The word 'SRS' and the SRS symbol (●) are registered trademarks of SRS Labs, Inc. BBE and BBE symbol are trademarks of BBE Sound, Inc. and are licensed by BBE Sound, Inc. under U.S. Patent No. 4,638,258 and 4,482,866.

© 2004 Dolby Laboratories, Inc.
Dolby, Pro Logic, and the double-D symbol are registered trademarks of Dolby Laboratories.

Design and specifications are subject to change without notice.

WARNINGS AND CAUTIONS

CAUTION

Short circuit the anode of the picture tube and the anode cap to the metal chassis, CRT shield, or carbon painted on the CRT, after removing the anode.

WARNING!!

An isolation transformer should be used during any service to avoid possible shock hazard, because of live chassis. The chassis of this receiver is directly connected to the AC power line.



SAFETY-RELATED COMPONENT WARNING!!

Components identified by shading and  mark on the schematic diagrams, exploded views, and in the parts list are critical for safe operation. Replace these components with Sony parts whose part numbers appear as shown in this manual or in supplements published by Sony. Circuit adjustments that are critical for safe operation are identified in this manual. Follow these procedures whenever critical components are replaced or improper operation is suspected.

ATTENTION!!

Après avoir déconnecté le cap de l'anode, court-circuiter l'anode du tube cathodique et celui de l'anode du cap au châssis métallique de l'appareil, ou la couche de carbone peinte sur le tube cathodique ou au blindage du tube cathodique.

Afin d'éviter tout risque d'électrocution provenant d'un châssis sous tension, un transformateur d'isolement doit être utilisé lors de tout dépannage. Le châssis de ce récepteur est directement raccordé à l'alimentation du secteur.



ATTENTION AUX COMPOSANTS RELATIFS A LA SECURITE!!

Les composants identifiés par une trame et par une marque  sur les schémas de principe, les vues explosées et les listes de pièces sont d'une importance critique pour la sécurité du fonctionnement. Ne les remplacer que par des composants Sony dont le numéro de pièce est indiqué dans le présent manuel ou dans des suppléments publiés par Sony. Les réglages de circuit dont l'importance est critique pour la sécurité du fonctionnement sont identifiés dans le présent manuel. Suivre ces procédures lors de chaque remplacement de composants critiques, ou lorsqu'un mauvais fonctionnement suspecte.

SAFETY CHECK-OUT

After correcting the original service problem, perform the following safety checks before releasing the set to the customer:

1. Check the area of your repair for unsoldered or poorly soldered connections. Check the entire board surface for solder splashes and bridges.
2. Check the interboard wiring to ensure that no wires are "pinched" or touching high-wattage resistors.
3. Check that all control knobs, shields, covers, ground straps, and mounting hardware have been replaced. Be absolutely certain that you have replaced all the insulators.
4. Look for unauthorized replacement parts, particularly transistors, that were installed during a previous repair. Point them out to the customer and recommend their replacement.
5. Look for parts which, though functioning, show obvious signs of deterioration. Point them out to the customer and recommend their replacement.
6. Check the line cords for cracks and abrasion. Recommend the replacement of any such line cord to the customer.
7. Check the B+ and HV to see if they are specified values. Make sure your instruments are accurate; be suspicious of your HV meter if sets always have low HV.
8. Check the antenna terminals, metal trim, "metallized" knobs, screws, and all other exposed metal parts for AC leakage. Check leakage as described below.

Leakage Test

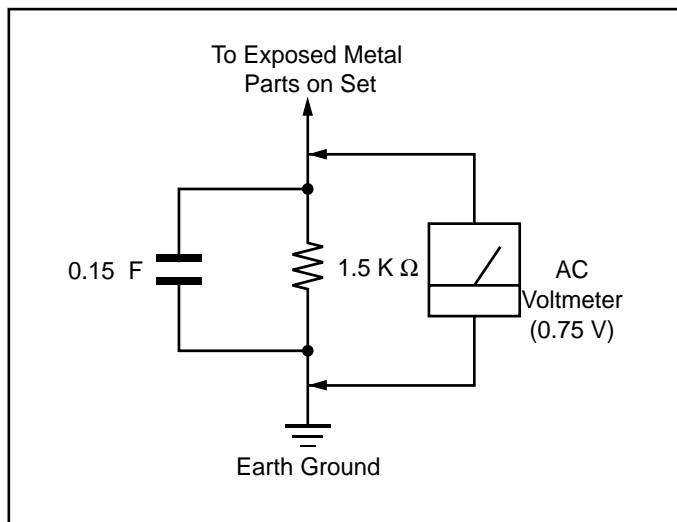

Figure A. Using an AC voltmeter to check AC leakage.

The AC leakage from any exposed metal part to earth ground and from all exposed metal parts to any exposed metal part having a return to chassis, must not exceed 0.5 mA (500 microamperes). Leakage current can be measured by any one of three methods.

1. A commercial leakage tester, such as the Simpson 229 or RCA WT-540A. Follow the manufacturers' instructions to use these instructions.
2. A battery-operated AC milliammeter. The Data Precision 245 digital multimeter is suitable for this job.
3. Measuring the voltage drop across a resistor by means of a VOM or battery-operated AC voltmeter. The "limit" indication is 0.75 V, so analog meters must have an accurate low voltage scale. The Simpson's 250 and Sanwa SH-63TRD are examples of passive VOMs that are suitable. Nearly all battery-operated digital multimeters that have a 2 VAC range are suitable (see Figure A).

How to Find a Good Earth Ground

A cold-water pipe is a guaranteed earth ground; the cover-plate retaining screw on most AC outlet boxes is also at earth ground. If the retaining screw is to be used as your earth ground, verify that it is at ground by measuring the resistance between it and a cold-water pipe with an ohmmeter. The reading should be zero ohms.

If a cold-water pipe is not accessible, connect a 60- to 100-watt trouble- light (not a neon lamp) between the hot side of the receptacle and the retaining screw. Try both slots, if necessary, to locate the hot side on the line; the lamp should light at normal brilliance if the screw is at ground potential (see Figure B).

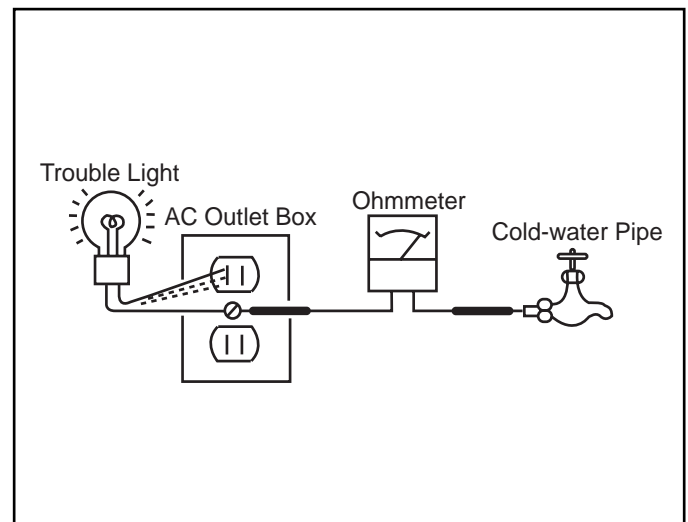

Figure B. Checking for earth ground.

SELF-DIAGNOSTIC FUNCTION



The units in this manual contain a self-diagnostic function. If an error occurs, the STANDBY/TIMER LED will automatically begin to flash. The number of times the LED flashes translates to a probable source of the problem. A definition of the STANDBY/TIMER LED flash indicators is listed in the instruction manual for the user's knowledge and reference. If an error symptom cannot be reproduced, the Remote Commander can be used to review the failure occurrence data stored in memory to reveal past problems and how often these problems occur.

Diagnostic Test Indicators

When an error occurs, the STANDBY/TIMER LED will flash a set number of times to indicate the possible cause of the problem. If there is more than one error, the LED will identify the first of the problem areas.

Results for all of the following diagnostic items are displayed on screen. No error has occurred if the screen displays a "0".

Diagnostic Item Description	No. of times STANDBY/ TIMER lamp flashes	Self-Diagnostic Display/ Diagnostic Result	Probable Cause Location	Detected Symptoms
Power does not turn on	Does not light	—————	<ul style="list-style-type: none"> Power cord is not plugged in. Fuse is burned out (F601). (A Board) 	<ul style="list-style-type: none"> Power does not come on. No power is supplied to the TV. AC Power supply is faulty.
+B overcurrent (OCP)*	2 times	2:0 or 2:1	<ul style="list-style-type: none"> H.OUT (Q505) is shorted. (A Board) IC2751 is shorted. (CW Board) 	<ul style="list-style-type: none"> Power does not come on. Load on power line is shorted.
I-Prot	4 times	4:0 or 4:1	<ul style="list-style-type: none"> +13V is not supplied. (A Board) IC545 is faulty. (A Board) 	<ul style="list-style-type: none"> Has entered standby state after horizontal raster. Vertical deflection pulse is stopped. Power line is shorted or power supply is stopped.
IK (AKB)	5 times	5:0 or 5:1	<ul style="list-style-type: none"> IC001 is faulty. (A Board) Screen (G2) is improperly adjusted.** 	<ul style="list-style-type: none"> No raster is generated. CRT Cathode current detection reference pulse output is small.

*If a +B overcurrent is detected, stoppage of the vertical deflection is detected simultaneously. The symptom that is diagnosed first by the microcontroller is displayed on the screen.

**Refer to Screen (G2) Adjustments in Section 2-4. of this manual.

Display of Standby/Timer LED Flash Count

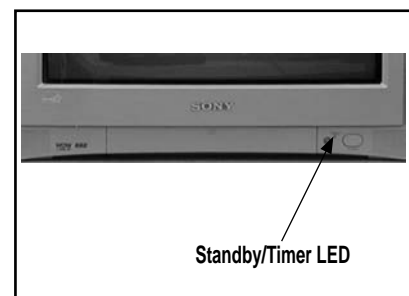
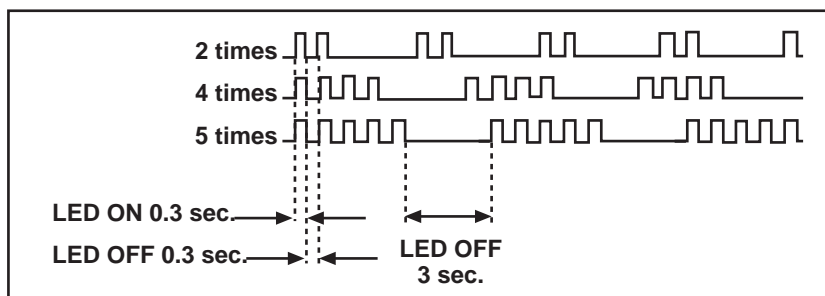

Diagnostic Item	Flash Count*
+B Overcurrent	2 times
I-Prot	4 times
IK (AKB)	5 times

*One flash count is not used for self-diagnostic.

Stopping the Standby/Timer LED Flash

Turn off the power switch on the TV main unit or unplug the power cord from the outlet to stop the STANDBY/TIMER LAMP from flashing.

Self-Diagnostic Screen Display

For errors with symptoms such as “power sometimes shuts off” or “screen sometimes goes out” that cannot be confirmed, it is possible to bring up past occurrences of failure on the screen for confirmation.

To Bring Up Screen Test

In standby mode, press buttons on the Remote Commander sequentially, in rapid succession, as shown below:



↑ Note that this differs from entering the Service Mode (Sound Volume +).

Self-Diagnostic Screen Display

SELF DIAGNOSTIC		
2: +B OCP	0	
3: +B OVP	N/A	
4: VSTOP	0	
5: AKB	1	
101: WDT	N/A	

Numeral “0” means that no fault was detected.
 Numerical “1” means a fault was detected one time only.

Handling of Self-Diagnostic Screen Display

Since the diagnostic results displayed on the screen are not automatically cleared, always check the self-diagnostic screen during repairs. When you have completed the repairs, clear the result display to “0”.

Unless the result display is cleared to “0”, the self-diagnostic function will not be able to detect subsequent faults after completion of the repairs.

Clearing the Result Display

To clear the result display to “0”, press buttons on the Remote Commander sequentially when the diagnostic screen is displayed, as shown below:



Quitting the Self-Diagnostic Screen

To quit the entire self-diagnostic screen, turn off the power switch on the Remote Commander or the main unit.

Self-Diagnostic Circuit

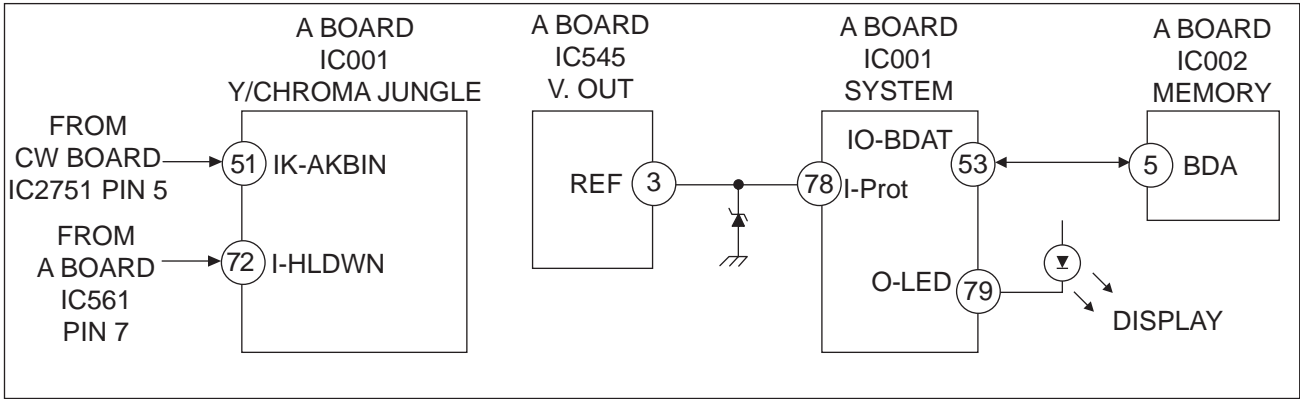

+B overcurrent (OCP)

Occurs when an overcurrent on the +B (135V) line is detected by pin 72 of IC001 (A Board). If the voltage of pin 72 of IC001 (A Board) is less than 1V when V.SYNC is more than seven verticals in a period, the unit will automatically turn off.

I-Prot

Occurs when an absence of the vertical deflection pulse is detected by pin 78 of IC001 (A Board). Power supply will shut down when waveform interval exceeds 2 seconds.

IK (AKB)

If the RGB levels* do not balance within 2 seconds after the power is turned on, this error will be detected by IC001 (A Board). TV will stay on, but there will be no picture.

*(Refers to the RGB levels of the AKB detection Ref pulse that detects 1K).

SECTION 1: DISASSEMBLY

1-1. REAR COVER REMOVAL (ALL EXCEPT KV-27FA310/29FA310)

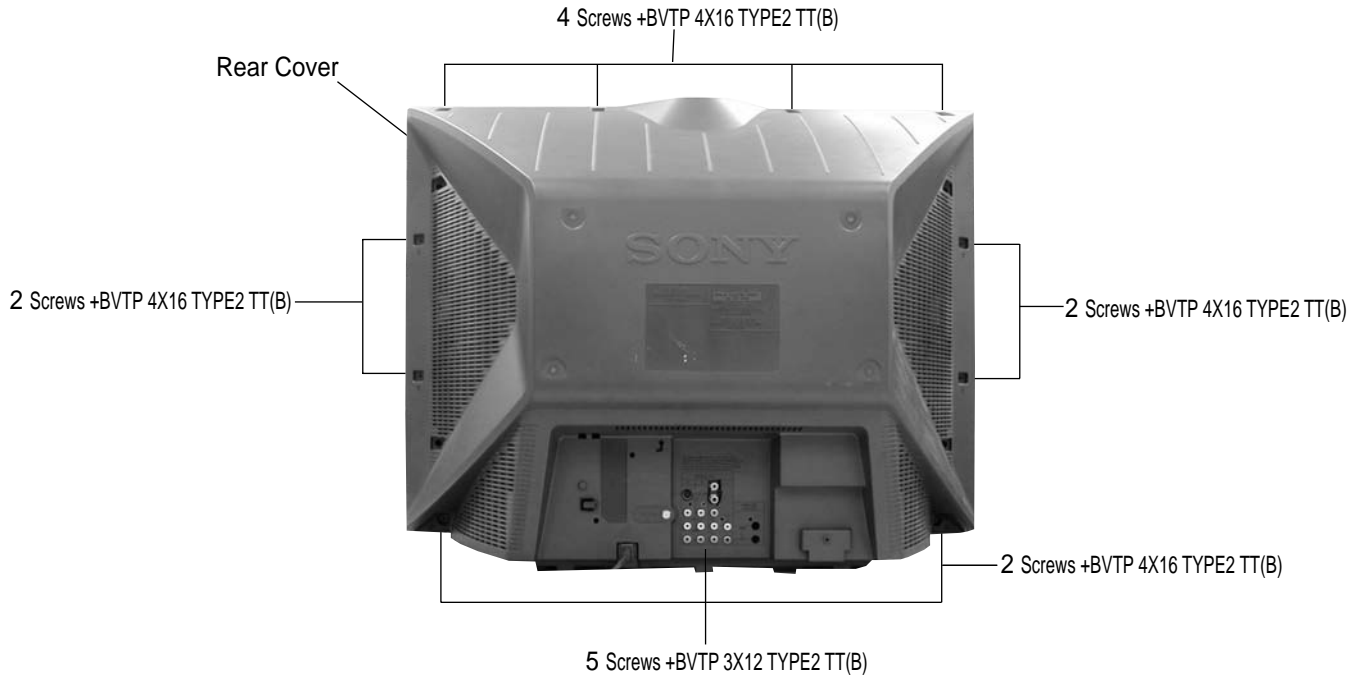

1-2. REAR COVER REMOVAL (KV-27FA310/29FA310 ONLY)

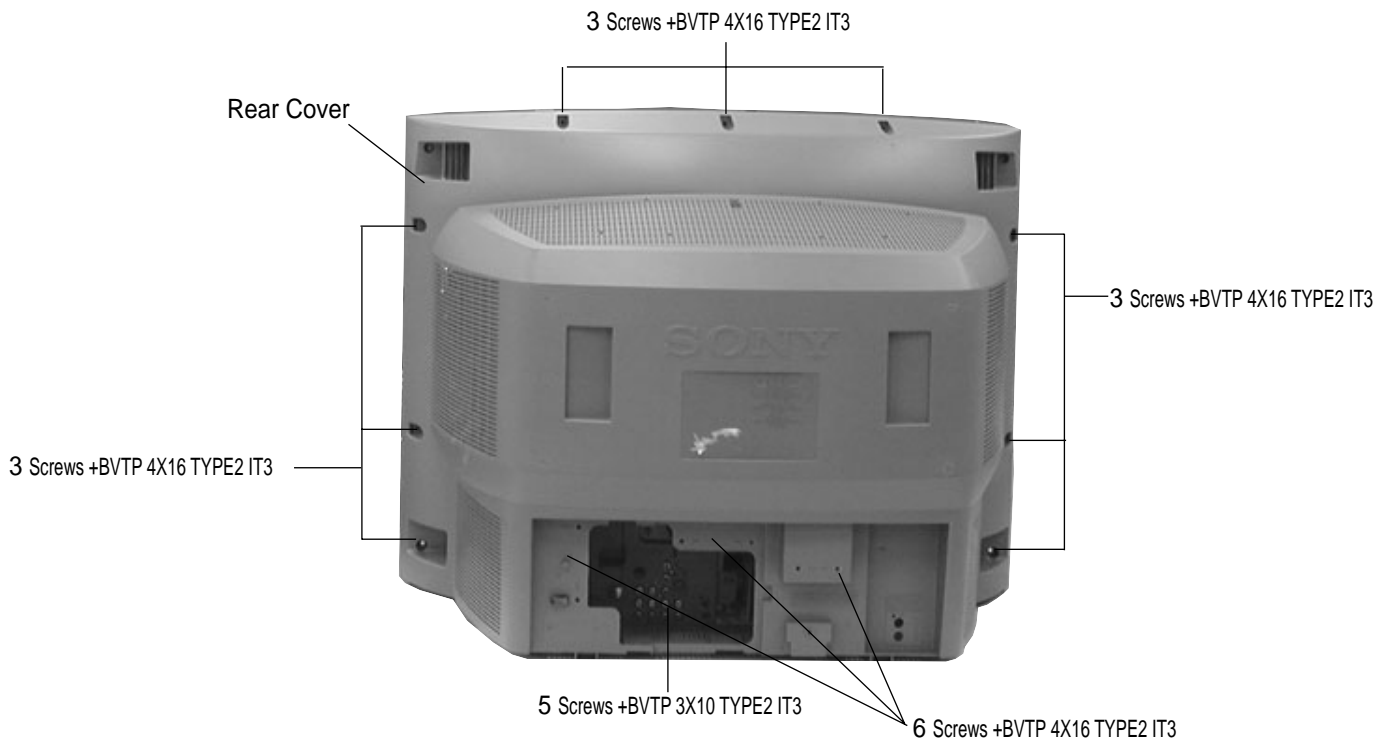

1-3. CHASSIS ASSEMBLY REMOVAL (ALL EXCEPT KV-27FA310/29FA310)

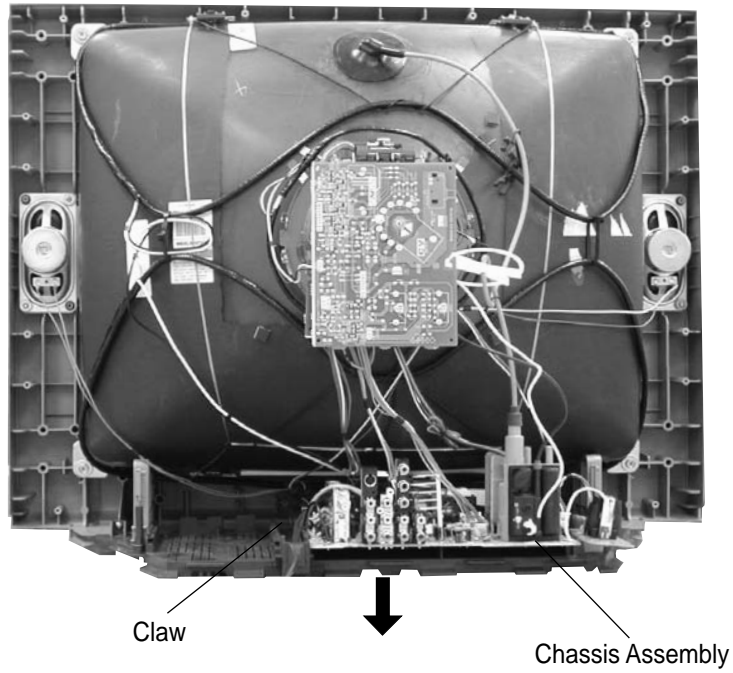

1-4. CHASSIS ASSEMBLY REMOVAL (KV-27FA310/29FA310 ONLY)

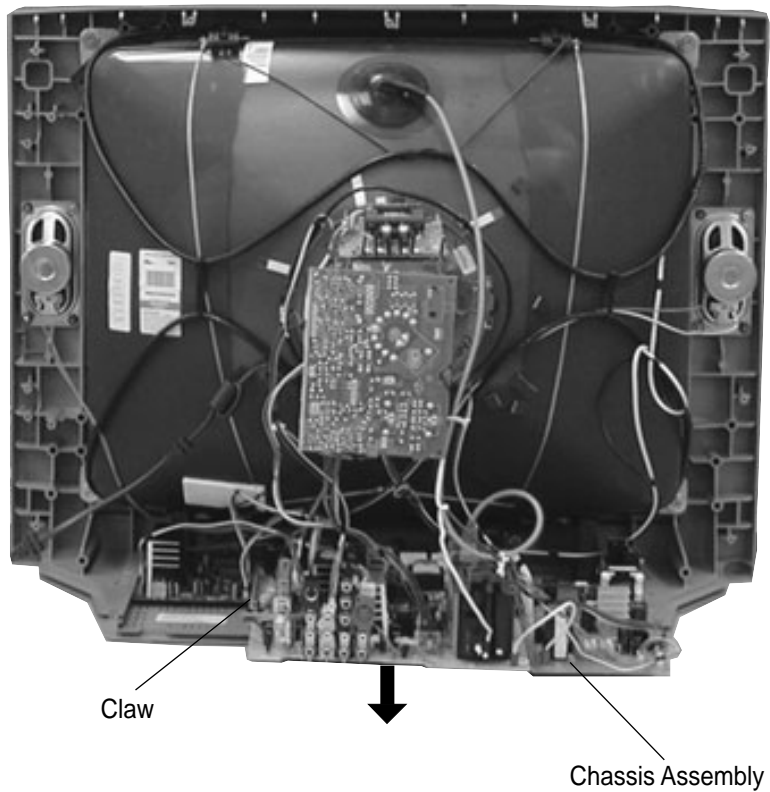

1-5. SERVICE POSITION (ALL EXCEPT KV-27FA310/29FA310)

- ① Press on catch tab to release A Board.
- ② Disconnect cables as needed to allow A Board to be removed.

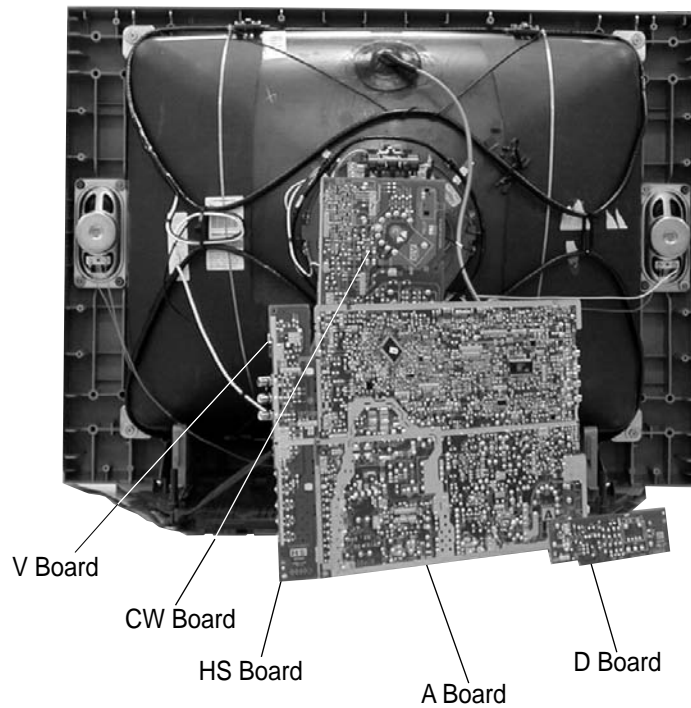

1-6. SERVICE POSITION (KV-27FA310/29FA310 ONLY)

- ① Press on catch tab to release A Board.
- ② Disconnect cables as needed to allow A Board to be removed.

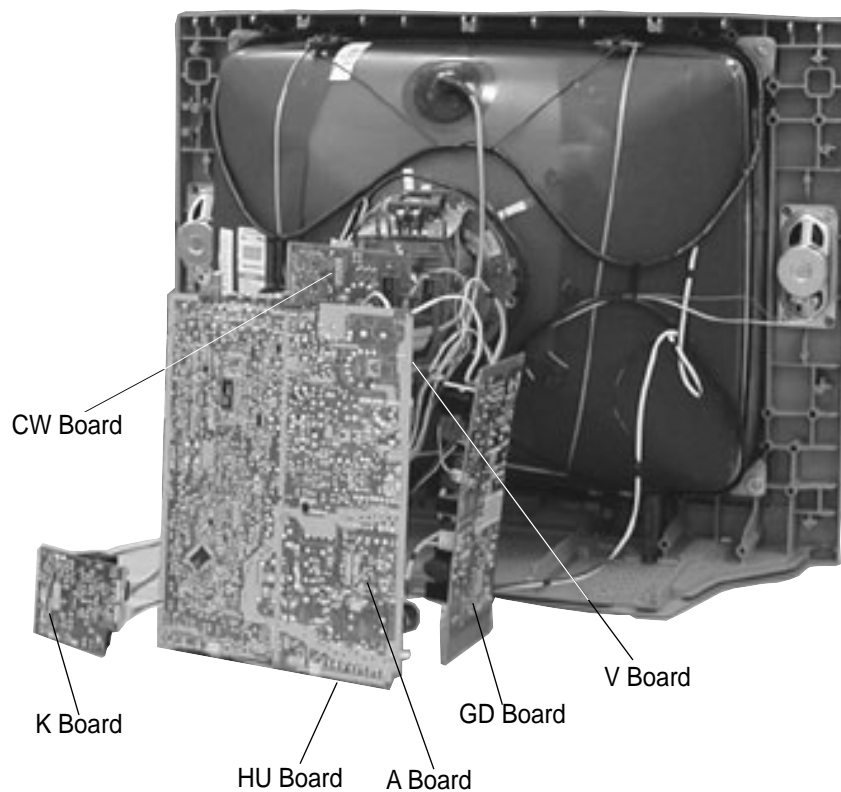

1-7. PICTURE TUBE REMOVAL

WARNING: BEFORE REMOVING THE ANODE CAP

High voltage remains in the CRT even after the power is disconnected. To avoid electric shock, discharge CRT before attempting to remove the anode cap. Short between anode and CRT coated earth ground strap.

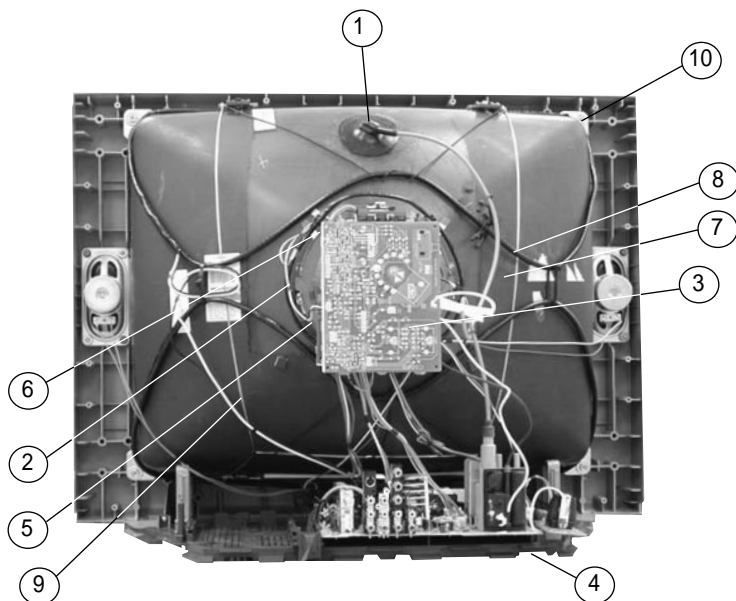
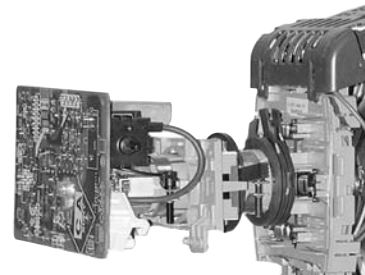

1. Discharge the anode of the CRT and remove the anode cap.
2. Unplug all interconnecting leads from the deflection yoke, neck assembly, degaussing coils and CRT grounding strap.
3. Remove the CW Board from the CRT.
4. Remove the chassis assembly.
5. Loosen the neck assembly fixing screw and remove.
6. Loosen the deflection yoke fixing screw and remove.
7. Place the set with the CRT face down on a cushion and remove the degaussing coil holders.
8. Remove the degaussing coils.
9. Remove the CRT grounding strap and spring tension devices.
10. Unscrew the four CRT fixing screws [located on each CRT corner] and remove the CRT [Take care not to handle the CRT by the neck].

ANODE CAP REMOVAL PROCEDURE

WARNING: High voltage remains in the CRT even after the power is disconnected. To avoid electric shock, discharge CRT **before** attempting to remove the anode cap. Short between anode and coated earth ground strap of CRT.

NOTE: After removing the anode cap, short circuit the anode of the picture tube and the anode cap to either the metal chassis, CRT shield, or carbon painted on the CRT.

REMOVAL PROCEDURES

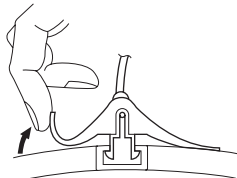
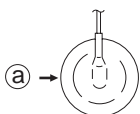

Turn up one side of the rubber cap in the direction indicated by arrow (a) .

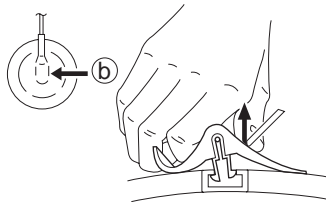

Use your thumb to pull the rubber cap firmly in the direction indicated by arrow (b) .

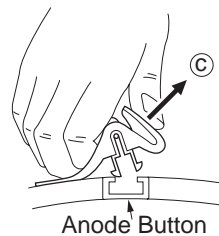

Anode Button

When one side of the rubber cap separates from the anode button, the anode cap can be removed by turning the rubber cap and pulling it in the direction of arrow (c) .

HOW TO HANDLE AN ANODE CAP

1. Do not use sharp objects which may cause damage to the surface of the anode cap.
2. To avoid damaging the anode cap, do not squeeze the rubber covering too hard. A material fitting called a shatter-hook terminal is built into the rubber.
3. Do not force turn the foot of the rubber cover. This may cause the shatter-hook terminal to protrude and damage the rubber.

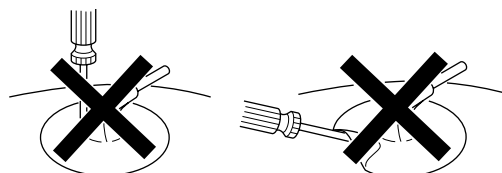

SECTION 2: SET-UP ADJUSTMENTS

The following adjustments should be made when a complete realignment is required or a new picture tube is installed.

These adjustments should be performed with rated power supply voltage unless otherwise noted.

Set the controls as follows unless otherwise noted:

VIDEO MODE: Pro

PICTURE CONTROL: Normal

BRIGHTNESS CONTROL: Normal

Perform the adjustments in order as follows:

1. Beam Landing
2. Convergence
3. Focus
4. Screen (G2)
5. White Balance

Note Test Equipment Required:

1. Color Bar Pattern Generator
2. Degausser
3. DC Power Supply
4. Digital Multimeter

2-1. BEAM LANDING

Before beginning adjustment procedure:

1. Feed in the white pattern signal.

Adjustment Procedure

1. Input a raster signal with the pattern generator.
2. Loosen the deflection yoke mounting screw, and set the purity control to the center as shown below:

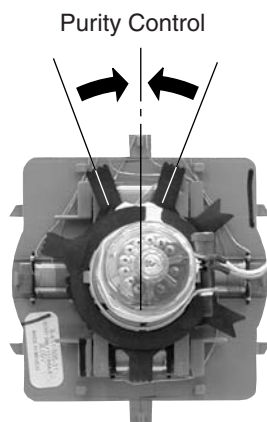

3. Turn the raster signal of the pattern generator to green.
4. Move the deflection yoke backward, and adjust with the purity control so that green is in the center and red and blue are even on both sides.

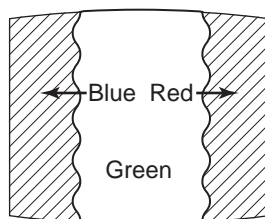

5. Move the deflection yoke forward, and adjust so that the entire screen becomes green.

6. Switch over the raster signal to red and blue and confirm the condition.
7. When the position of the deflection yoke is determined, tighten it with the deflection yoke mounting screw.
8. If landing at the corner is not right, adjust by using the disk magnets.

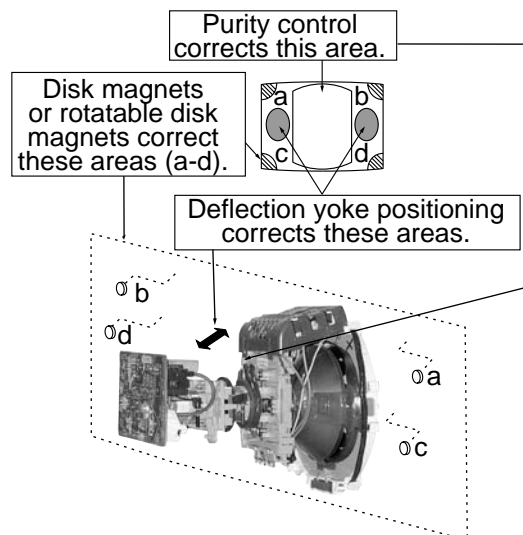
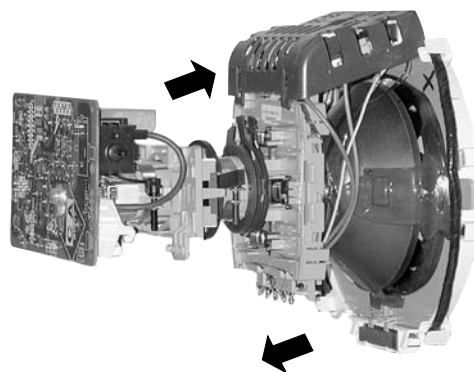

2-2. CONVERGENCE

Before starting convergence adjustments:

- 1 Perform FOCUS, VLIN and VSIZE adjustments.
2. Set BRIGHTNESS control to minimum.
3. Feed in dot pattern.

Vertical Static Convergence

1. Adjust V. STAT magnet to converge red, green and blue dots in the center of the screen.

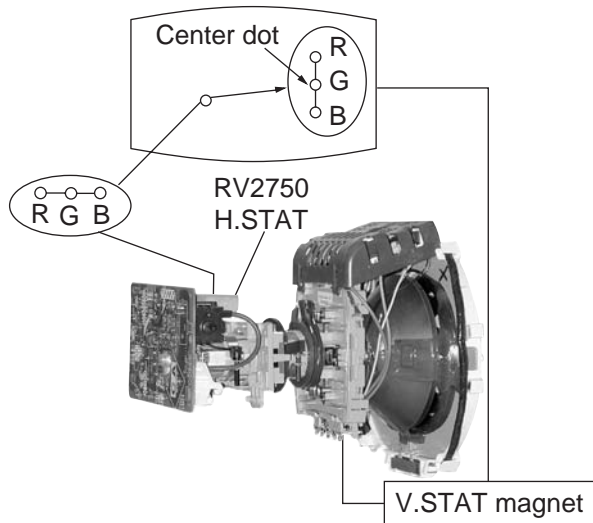

2. Tilt the V. STAT magnet and adjust static convergence to open or close the V. STAT magnet.

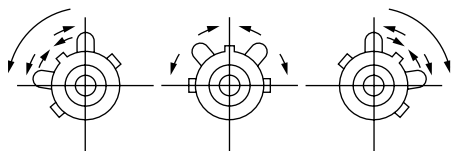

When the V. STAT magnet is moved in the direction of arrow a and b, red, green, and blue dots move as shown below:

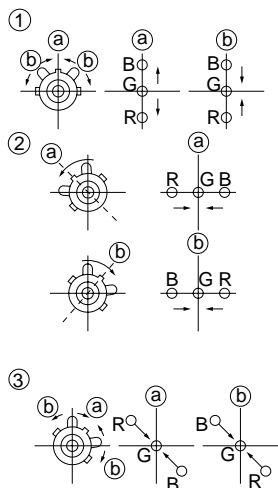

Horizontal Static Convergence

If the blue dot does not converge with the red and green dots, perform the following:

1. Move H STAT VR magnet (a) to correct insufficient H.Static convergence.

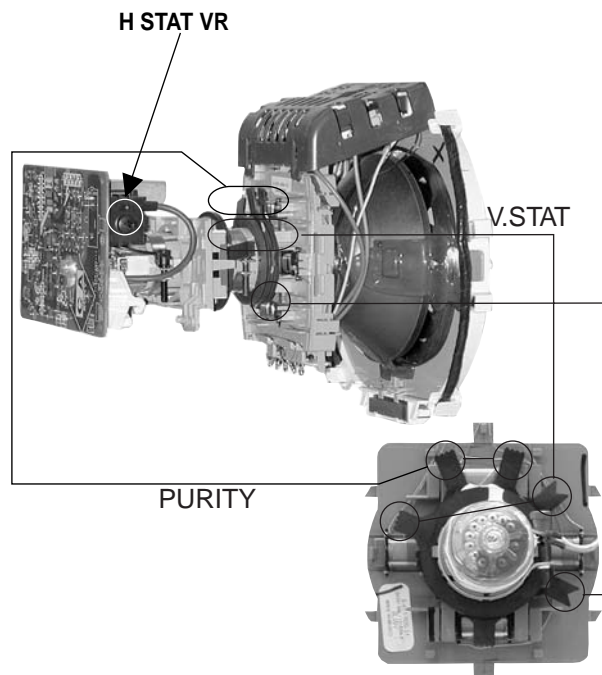

Dynamic Convergence Adjustment

Before performing this adjustment, perform Horizontal and Vertical Static Convergence Adjustment.

1. Slightly loosen deflection yoke screw.
2. Remove deflection yoke spacers.
3. Move the deflection yoke for best convergence as shown below:

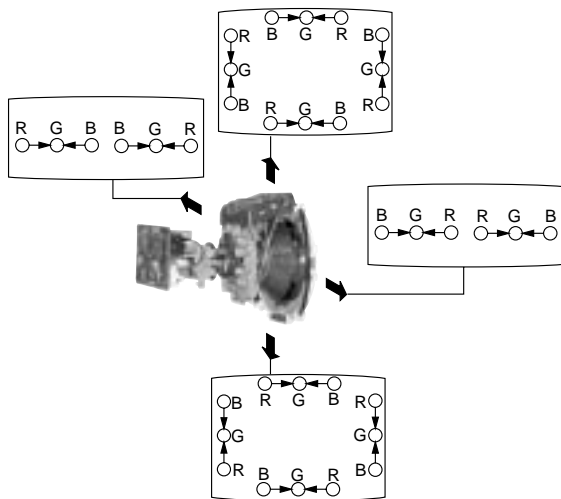

4. Tighten the deflection yoke screw.
5. Install the deflection yoke spacers.

TLH Plate Adjustment

1. Input crosshatch pattern.
2. Adjust PICTURE QUALITY to standard, PICTURE and BRIGHTNESS to 50%, and OTHER to standard.
3. Adjust the Horizontal Convergence of red and blue dots by tilting the TLH plate on the deflection yoke.

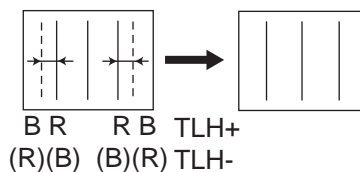
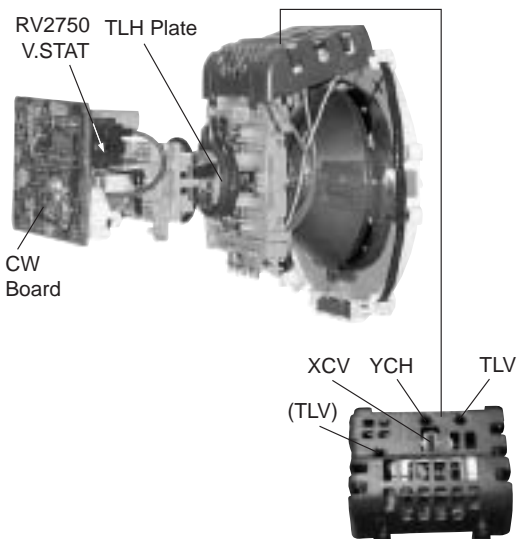

4. Adjust XCV core to balance X axis.
 5. Adjust YCH VR to balance Y axis.
 6. Adjust vertical red and blue convergence with V.TILT (TLV VR.)
- Note: Perform adjustment 3-6 while tracking items 1 and 2.

Screen-Corner Convergence

1. Affix a permalloy assembly corresponding to the misconverged areas:

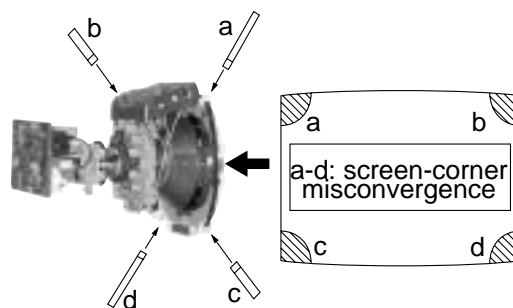

2-3. FOCUS

1. Adjust FOCUS control for best pictures.

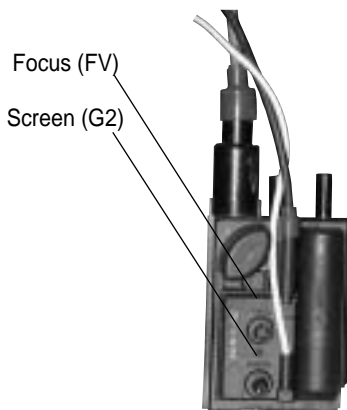

2-4. SCREEN (G2)

1. Input a dot pattern.
2. Set the PICTURE and BRIGHTNESS controls at minimum and COLOR control at normal.
3. Adjust SBRT, GCUT, BCUT in service mode with an oscilloscope as shown below so that voltages on the red, green, and blue cathodes are $160 \pm 2\text{VDC}$.

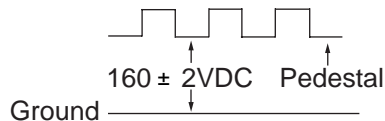

4. Observe the screen and adjust SCREEN (G2) VR in FBT to obtain the faintly visible background of dot signal.

2-5. METHOD OF SETTING THE SERVICE ADJUSTMENT MODE

Service Mode Procedure

1. Standby mode (power off).
2. Press **Display** → Channel **5** → Sound Volume **+** → Power on the Remote Commander (press each button within a second).

Service Adjustment Mode On

1. The CRT displays the time being adjusted.

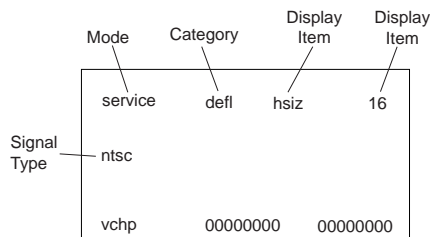

2. Press **1** or **4** on the Remote Commander to select the time.
3. Press **3** or **6** on the Remote Commander to change the data.
4. Press **MUTING** then **ENTER** to save into the memory.

Service Adjustment Mode Memory

Turn the set off then on to exit Service Adjustment Mode.

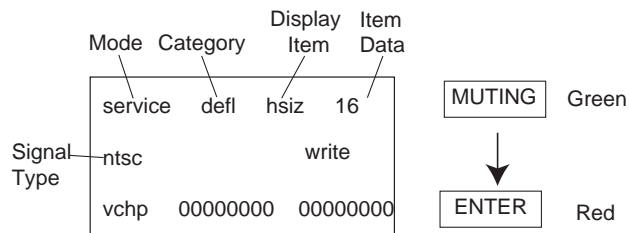



2-6. WHITE BALANCE ADJUSTMENTS

1. Input an entire white signal with burst.
2. Set to Service Adjustment Mode.
3. Set the PICTURE and BRIGHTNESS to minimum.
4. Adjust with SBRT if necessary.
5. Select GCUT and BCUT with **1** and **4**.
6. Adjust with **3** and **6** for the best white balance.
7. Set the PICTURE and BRIGHTNESS to maximum.
8. Select GDRV and BDRV with **1** and **4**.
9. Adjust with **3** and **6** for the best white balance.
10. Press **MUTING** then **ENTER** to save into the memory.

SECTION 3: SAFETY RELATED ADJUSTMENTS

3-1. R564 CONFIRMATION METHOD (HV HOLD-DOWN CONFIRMATION) AND READJUSTMENTS

The following adjustments should always be performed when replacing the following components which are marked with  on the schematic diagram:

Part Replaced ()	Adjustment ()
DY, T585, CRT, IC001, IC561, IC600, IC604, C506, C507, C508, C510, C511, C513, C514, L588, D566, D567, D568, PH602, R526, R564, R565, R566, R851, T510, T511.....A Board	HV HOLD-DOWN R564

Preparation Before Confirmation

- Using a Variac, apply AC input voltage: 120 ± 2 VAC.
- Turn the POWER switch ON.
- Input a white signal and set the PICTURE and BRIGHTNESS controls to maximum.
- Confirm that the voltage between C566 (+) or TP30 and ground is more than 99VDC.

Hold-Down Operation Confirmation

- Connect the current meter between Pin 11 of the FBT (T585) and the PWB land where Pin 11 would normally attach (See Figure 1 on the next page).
- Input a dot signal and adjust the ABL current to follow with the PICTURE and BRIGHTNESS control: $IABL = 140 \pm 100\mu\text{A}$.
- Confirm the voltage of A Board TP-23 is $135.6 \pm 1.0\text{VDC}$.
- Connect the digital voltmeter and the DC power supply via Diode 1SS119 to C566 (+) and ground (See Figure 1 on next page).
- Increase the DC power voltage gradually until the picture blanks out.
- Turn DC power source off immediately.
- Read the digital voltmeter indication (Standard $\leq 114.6 +0\text{VDC}/-0.3\text{DC}$).
- Input 100 IRE White Signal and adjust the ABL current to follow with the PICTURE and BRIGHTNESS control: $IABL = 1820\mu\text{A} \pm 200\mu\text{A}$.
- Repeat steps 4 through 7.

Hold-Down Readjustment

If the setting indicated in Step 2 of Hold-Down Operation Confirmation cannot be met, readjustment should be performed by altering the resistance value of R564 component marked with .

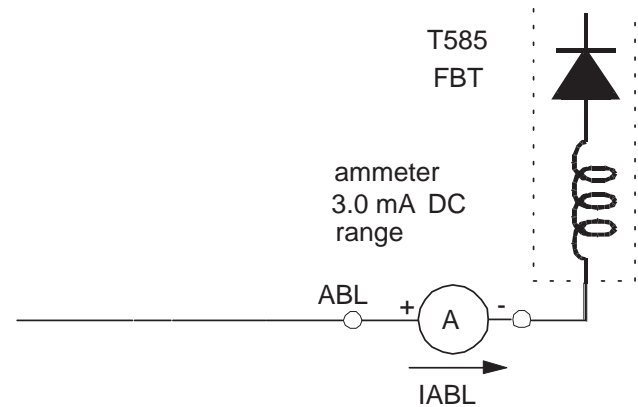

3-2. B+ VOLTAGE CONFIRMATION AND ADJUSTMENT

Note: The following adjustments should always be performed when replacing the following components, which are marked with  on the schematic diagram on the A Board:

A BOARD:  IC604, PH602

- Using a Variac, apply AC input voltage: $130 + 2.0 / - 0.0$ VAC.
- Input a DOT pattern at Q.C.
- Set the PICTURE and the BRIGHTNESS controls to minimum.
- Confirm the voltage of A Board between TP-23 & Ground is $=135.6 \pm 1\text{VDC}$.
- If step 4 is not satisfied, replace the components listed above, then repeat steps 1 through 3.

FIGURE 1

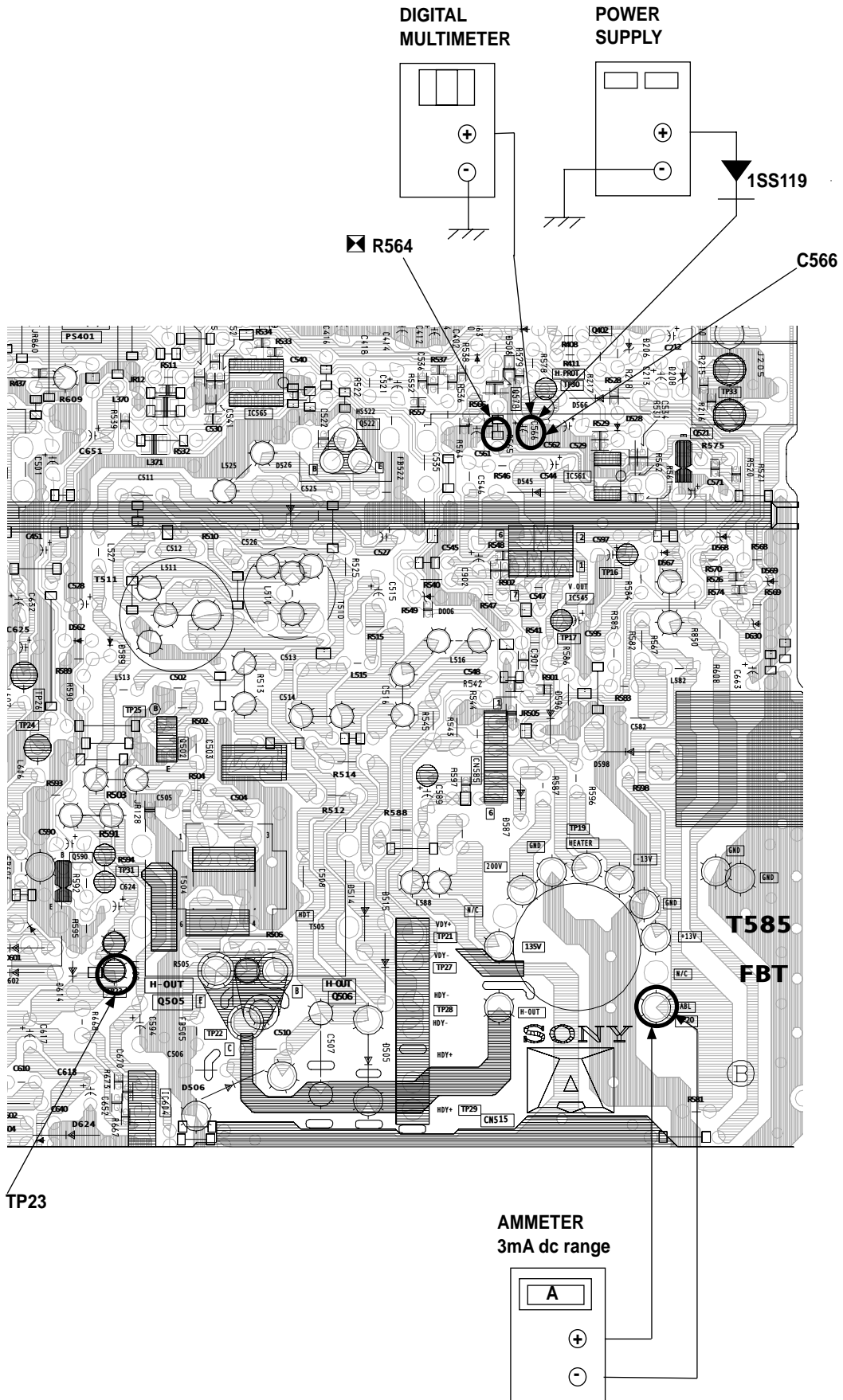

SECTION 4: CIRCUIT ADJUSTMENTS

Electrical Adjustments by Remote Commander

Use the Remote Commander (RM-Y180, RM-Y195) to perform the circuit adjustments in this section.

Test Equipment Required: 1. Pattern generator 2. Frequency counter 3. Digital multimeter 4. Audio oscillator

4-1. SETTING THE SERVICE ADJUSTMENT MODE

- Standby mode (Power off).
- Press the following buttons on the remote commander within a second of each other:

Display → **Channel 5** → **Sound Volume +** → **Power**

Service Adjustment Mode On

- The CRT displays the item being adjusted.

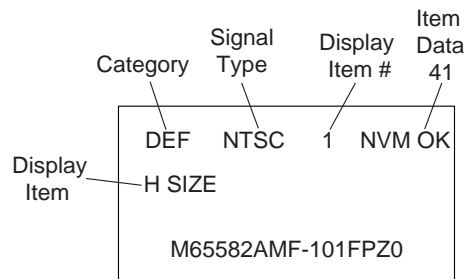

- Press **1** or **4** on the Remote Commander to select the item.
- Press **3** or **6** on the Remote Commander to change the data.
- Press **MUTING** then **ENTER** to write into memory.

Service Adjustment Mode Memory

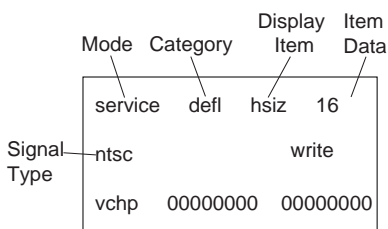

- Press **8** then **ENTER** on the Remote Commander to initialize.

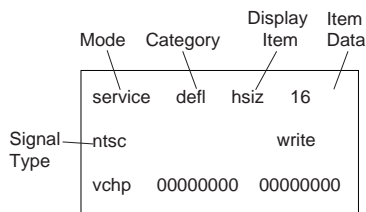

Carry out Step 1 when adjusting IDs 0-7 and when replacing and adjusting IC002

- Press **MUTING** then **ENTER** to write into memory.
- Turn set off then on to exit Service Adjustment Mode.

4-2. MEMORY WRITE CONFIRMATION METHOD

- After adjustment, pull out the plug from the AC outlet, then replace the plug in the AC outlet again.
- Turn the power switch ON and set to Service Mode.
- Call the adjusted items again to confirm they were adjusted.

4-3. REMOTE ADJUSTMENT BUTTONS AND INDICATORS

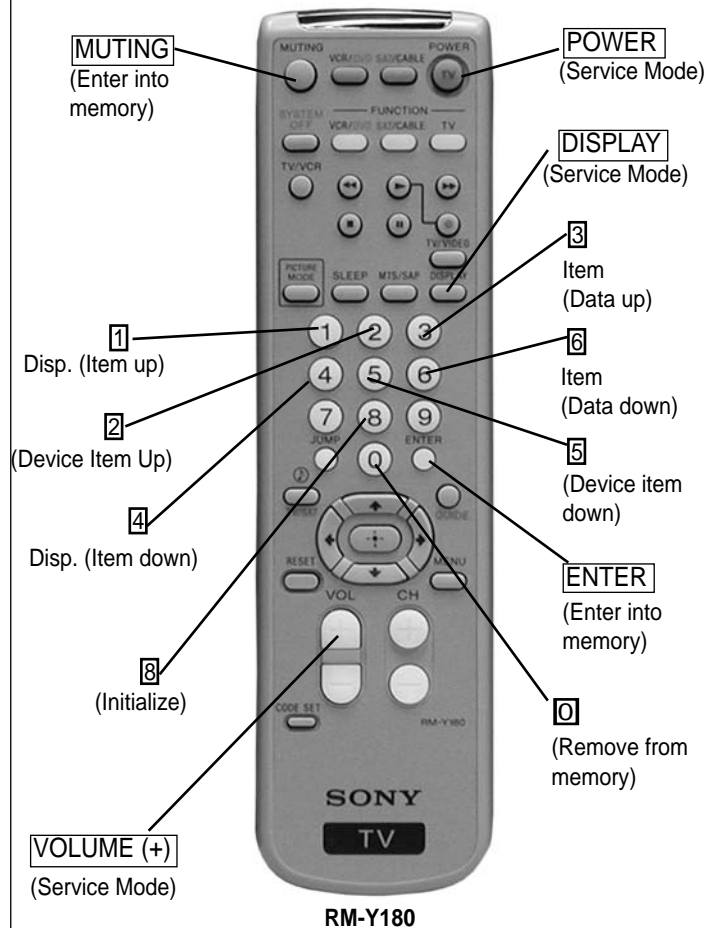

4-4. SERVICE DATA LISTS

Service Group	Fix/Var	No.	Name	Description	NTSC Init Data
VERSION	Fix	0	VER	Microprocessor version information	=
DEF	VAR	1	HSIZ	H-SIZE (EW DC : YUV OFFSET)	47
	VAR	2	HPOS	H POSITION: YUV OFFSET	36
	VAR	3	VSIZ	V RAMP SIZE: YUV OFFSET	28
	VAR	4	VPOS	V POSITION (RAMP DC) NOT USEFUL: YUV OFFSET	37
	VAR	5	VLIN	V LINEARITY	32
	VAR	6	SCOR	S CORRECTION	49
	VAR	7	VBOW	BOW	31
	VAR	8	VANG	ANGLE	37
	VAR	9	TRAP	EW TRAPESIUM	24
	VAR	10	PAMP	PARABOLA (EW PIN)	49
	VAR	11	UPIN	UPPER CORNER (UPPER PIN)	31
	VAR	12	LPIN	LOWER CORNER (LOWER PIN)	30
	VAR	13	TROT	TROT	109
	VAR	14	HBLK	FBPBLK (H BLK MODE SELECT)	0
	VAR	15	RBLK	HBLK R POS (HBLK REAR TIMING: YUV OFFSET)	15
	VAR	16	LBLK	HBLK F POS (HBLK FRONT TIMING: YUV OFFSET)	41
	FIX	17	VBLK	VBLK POS (V BLK WIDTH)	0
	FIX	18	HMSK	Macro OFF (TOP VEND [WHEN MACROVISION] PREVENT OFF)	0
	FIX	19	HDW	IIC_HOUT_DUTY (H PULSE WIDTH [25u/19u]	1
	FIX	20	AFC	H AFC Gain (AFC GAIN)	0
	FIX	21	AFC1	H Charge pump (AFC1 TIME CONSTANT)	3
	FIX	22	AFCW	AFC1 PULLIN (AFC1 PULL IN WIDE)	0
	FIX	23	CDMD	V CD MODE (V DET WINDOW SW TIMING)	1
	FIX	24	HSS	SYNC SLICE LVL(H) (SYNC SLICE LEVEL [H sepa])	0
	FIX	25	VSS	SYNC SLICE LVL(L) (SYNC SLICE LEVEL [V sepa])	3
	FIX	26	SLDN	AUTO SLICE DOWN (AUTO SLICE LEVEL DOWN)	0
	FIX	27	SLUP	AUTO SLICE UP (AUTO SLICE LEVEL UP)	0
	FIX	28	JPSW	VJPSW (JUMP SW)	0
	FIX	29	HOSC	H VCO FOR OFFSET ADJUST OFFSET	7
	FIX	30	EHT	EHT	4
	FIX	31	EHTG	EHT GAIN (EHT MODE)	1

Service Group	Fix/Var	No.	Name	Item name & (Description)	NTSC Init Data
16 : 9	VAR	1	VSIZ	V RAMP SIZE	48
	VAR	2	VPOS	V POSITION (RAMP DC)	40
	VAR	3	VLIN	V LINEARITY	26
	VAR	4	SCOR	S CORRECTION	24
	VAR	5	TRAP	EW TRAPESIUM	22
	VAR	6	PAMP	PARABOLA (EW PIN)	24
	VAR	7	UPIN	UPPER CORNER (UPPER PIN)	31
	VAR	8	LPIN	LOWER CORNER (LOWER PIN)	31
	VAR	9	ABLG	ABL GAIN	15
	VAR	10	SCON	SUB CONTRAST LEVEL	13
	VAR	11	VPW	JUMP PULSE WIDTH	1

Service Group	Fix/Var	No.	Name	Item name & (Description)	NTSC Init Data	Video	YUV	16:09
VP1	VAR	1	RDRV	R DRIVE	64	64	64	N/A
	VAR	2	GDRV	G DRIVE: GDOF OFFSET (only Color Temp. "Warm")	45	45	48	N/A
	VAR	3	BDRV	B DRIVE: BDOF OFFSET (only Color Temp. "Warm")	45	45	44	N/A
	VAR	4	RCUT	HARDWARE AKB (R) CMP DATA	120	120	120	N/A
	VAR	5	GCUT	HARDWARE AKB (G) CMP DATA	91	91	90	N/A
	VAR	6	BCUT	HARDWARE AKB (B) CMP DATA	87	87	105	N/A
	VAR	7	SCON	SUB CONTRAST LEVEL	19	19	19	N/A
	VAR	8	SHUE	SUB TINT (HUE)	7	7	7	N/A
	VAR	9	SCOL	SUB COLOR LEVEL	14	14	24	N/A
	VAR	10	SBRT	SUB BRIGHTNESS	13	13	15	N/A
	FIX	11	RON	R OUTPUT ON (0:R OUTPUT OFF 1:R OUTPUT ON)	1			
	FIX	12	GON	G OUTPUT ON (0:R OUTPUT OFF 1:R OUTPUT ON)	1			
	FIX	13	BON	B OUTPUT ON (0:R OUTPUT OFF 1:R OUTPUT ON)	1			
	FIX	14	BLLV	BLUE STRETCH (00:NO<->11:DEEP) only Color Temp "Cool"	1			
	FIX	15	MTRX	MATRIX RATIO SELECT	0			
	FIX	16	AXIS	R-Y PHASE SELECT	52			
	VAR	17	SSHO	SUB SHARPNESS GAIN (OVER) RF/VIDEO	10	25	25	N/A
	VAR	18	SSHP	SUB SHARPNESS GAIN (PRE) RF/VIDEO	15	30	30	N/A
	VAR	19	SHPF	SHARPNESS FOR (00:2 CLK <-> 11:5 CLK)	1	0	0	N/A
	FIX	20	SHCL	SHARPNESS CORING LEVEL	0			
	FIX	21	SHMX	SHARPNESS LIMITER LEVEL	15			
	FIX	22	ACLV	ACL GAIN	0			
	FIX	23	AKBD	AKB SELF DIAGNOSTIC COUNTER (@1 SEC)	2			
	FIX	24	AKBS	AKB SWITCH (0:AKB OFF 1:H/W AKB ON)	1			
	FIX	25	REFP	AKB REFPLS TIMING	0			
	FIX	26	YNRC	YNR LIMITER LEVEL	15			
	FIX	27	BKON	BLACK STRETCH ON	1			
	FIX	28	BKAT	BLACK STRETCH DETECTOR TIME CONSTANT1	15			
	FIX	29	BKRC	BLACK STRETCH DETECTOR TIME CONSTANT2	4			
	FIX	30	BKDP	BLACK STRETCH DEPTH	soft cont'l			
	FIX	31	BKSP	BLKSTPNT BLACK STRETCH POINT	2			

Service Group	Fix/Var	No.	Name	Item name & (Description)	NTSC Init Data	Video	YUV	16:09
VP2	FIX	1	VMOF	VM GAIN(Off) (VM LEVEL AT "OFF" SETTING)	2			
	FIX	2	VMLO	VM GAIN(Low) (VM LEVEL AT "LOW" SETTING)	4			
	FIX	3	VMHI	VM GAIN(High) (VM LEVEL AT "HIGH" SETTING)	7			
	FIX	4	VMDL	VM DELAY (VM DELAY)	6			
	FIX	5	VMPL	VM POL (VM POLARITY)	0			
	FIX	6	VMWD	VM WIDTH (VM WIDTH)	0			
	FIX	7	VMCL	VM CORING LEVEL (VM CORING LEVEL)	0			
	FIX	8	VMMX	VM MAX (VM LIMITER LEVEL)	15			
	FIX	9	CKLV	KILLER LEVEL (VM COLOR KILLER VTH)	1	1	0	N/A
	FIX	10	CKON	FORCE KILLER (FORCE KILLER)	0			
	FIX	11	ALFA	ALFA (ADAPTIVE DET SENSITIVITY)	2			
	FIX	12	YCMD	MANEXP (YC SEPA FORCE SELECT [00:ADAPTIVE 01:H 10:V 11:HV])	0			
	FIX	13	VACL	V APERTURE CORING LV (V APERTURE CORING LEVEL)	0			
	FIX	14	VAGA	V APERTURE GAIN (V APERTURE GAIN LEVEL)	soft cont'l			
	FIX	15	VAMX	V APERTURE MAX GAIN (V APERTURE LIMITER LEVEL)	5			
	FIX	16	GAMM	GAMMA (GAMMA [00:NO <-> 11:DEEP])	soft cont'l			
	FIX	17	YDLY	Y DELAY (Y DELAY TIME)	1	1	3	N/A
	FIX	18	CDLY	C DELAY (C DELAY TIME)	0			
	FIX	19	YOFF	Y Mute (Y OUTPUT MUTE)	0			
	FIX	20	CBPF	SAW FILTER(7.2MHzBPF) (C BPF FOR HI)	0			
	FIX	21	BGPP	BGP POS (BGP [FOR C DECODER] TIMING)	9	9	28	N/A
	VAR	22	GDOF	G DRIVE OFFSET only Color Temp. "Warm"	9			
	VAR	23	BDOF	B DRIVE OFFSET only Color Temp. "Warm"	14			
	VAR	24	GCOF	G CUT CMP DATA OFFSET only Color Temp. "Warm"	11			
	VAR	25	BCOF	B CUT CMP DATA OFFSET only Color Temp. "Warm"	28			
	VAR	26	DCTV	DCTRAN VTH<6:0> (DCTTRANSFER VTH)	30			
	FIX	27	DCTG	DCTRAN GAIN<4:0> (DCTTRANSFER GAIN)	soft cont'l			

Service Group	Fix/Var	No.	Name	Item name & (Description)	NTSC Init Data
NR	VAR	1	SCOL	SUB COLOR LEVEL	14
	VAR	2	SHCL	SHARPNESS CORING LEVEL	15
	VAR	3	SHMX	SHARPNESS LIMITER LEVEL	7
	FIX	4	YNRC	YNR LIMITER LEVEL	7
	FIX	5	VMHI	VM LEVEL AT " HIGH " SETTING	10
	FIX	6	VMCL	VM CORING LEVEL	0
	FIX	7	VMMX	VM LIMITER LEVEL	7
	FIX	8	VAMX	V APERTURE LIMITER LEVEL	0
	FIX	9	GAMM	GAMMA (00: NO < - > 11:DEEP)	0
	FIX	10	YNRS	YNR ON	1
	FIX	11	WSTH	WEAK SIGNAL VTH	7
	FIX	12	WSVA	WEAK SIGNAL VIDEO ATT	0
	FIX	13	WSCA	WEAK SIGNAL CHROMA ATT	5
	FIX	14	NRCH	THRNV1(NOISE DET TIME CONSTANT)	0
	FIX	15	NRCL	THRNV2 (NOISE DET TIME CONSTANT)	16
	FIX	16	NRVL	THRNVH1 (NOISE DET VTH)	2
	FIX	17	NRVH	THRNVH2 (NOISE DET VTH)	0
	FIX	18	IPNC	DETNZ STATUS COUNTER	2
	FIX	19	IPNV	DETECTION PERIOD	10

Service Group	Fix/Var	No.	Name	Item name & (Description)	NTSC			
					BA6 DATA (DEC)			
					PALLET = VIVID	PALLET = STD	PALLET = MOVIE	PALLET = PRO
PALLET	FIX	1	VPIC	PICTURE	63	50	37	31
	FIX	2	VBRI	BRIGHTNESS	27	30	31	31
	FIX	3	VCOL	COLOR	37	32	31	31
	FIX	4	VHUE	HUE	31	31	31	31
	FIX	5	VSHA	SHARPNESS	31	32	31	21
	FIX	6	VVM	VM	2	1	0	0
	FIX	7	VTRI	COLOR TEMP	0	1	2	1
	FIX	8	VAPA	APERTURE G	5	5	3	0
	FIX	9	VGMA	GAMMA	3	1	0	0
	FIX	10	VDCT	DCT LV	23	15	2	2
	FIX	11	VBKP	BLACK STRETCH DEPTH (VIDEO)	3	3	4	7
	FIX	12	TBKD	BLACK STRETCH DEPTH (TUNER)	3	3	4	7

Service Group	Fix/Var	No.	Name	Item name & (Description)	NTSC Init Data
Y	FIX	1	YNRS	YNR SW (YNR ON)	0
	FIX	2	YTHR	Y THR 2D (Y SIGNAL THROUGH 2DYCS)	0
	FIX	3	Y2D	Y2D Fix (Y SIGNAL GENERATE from 2DYCS)	0
	FIX	4	2DFX	C BPF Fix (C SIGNAL GENERATE from H/V BPF only	1
	FIX	5	CLPS	CLAMP CONTROL SW (0: CLAMP OFF. 1: CLAMP AUTO. 2: CLAMP ON]	1
	FIX	6	VLPF	VIDEO LPF (Y_LPF [ANALOG] for adjust)	3
	FIX	7	CLPF	CHROMA LPF (C_LPF [ANALOG] for adjust)	3
	FIX	8	BPFB	YCS HBBPF BACK (YCS HBBPF SELECT [BACK])	1
	FIX	9	BFFF	YCS HBBPF FRONT (YCS HBBPF SELECT [FRONT])	1
	FIX	10	BKTS	BS T2 IFON (BLACK STRETCH RECOVER TIME OUT	0
	FIX	11	VMG ₂	VMGAIN ₂ (MODULATOR FEEDBACK GAIN CONTROL	3
	FIX	12	CLPT	CLAMP KEEP TIMER (CLAMP AUTO ON KEEP TIMER COUNT [@ 100 MS])	15

Service Group	Fix/Var	No.	Name	Item name & (Description)	A8 Init Data	Video	YUV	16:09
C	FIX	1	A1FL	AMP OFF1 L (ANALOG ACC hysteresis)	90	0	1	N/A
	FIX	2	A1ON	AMP ON (ANALOG ACC AMP ON LEVEL)	4			
	FIX	3	ACCS	ACC SW (ACC ON/OFF)	0			
	FIX	4	AASL	AVE SEL (C DECODER TIME CONSTANT [32, 16, 8, 1H])	2	0	1	N/A
	FIX	5	BASL	B2AVE SEL (ACC TIME CONSTANT)	0			
	FIX	6	XFFR	FREE RUN (VCXO FORCE FREERUN)	0			
	FIX	7	A2ON	AMP2 ON Thresh (ABL VTH)	4			
	FIX	8	A3ON	AMP3 ON Thresh (ACL VTH)	4			
	FIX	9	A2FL	AMP2 OFF Thresh L (AMP2 OFF LEVEL LOWER)	64			
	FIX	10	A3FL	AMP3 OFF Thresh L (AMP3 OFF LEVEL LOWER)	64			
	FIX	11	AXTH	AXIS HYS (AXS HYS)	30			
	FIX	12	ACTH	ROM HYS (ROM HYS)	10			
	FIX	13	AVAV	AVE SEL AV (AVE SEL AV)	3			
	FIX	14	B2TH	B2COMP (B2COMP)	0			
	FIX	15	ACCP	ACC COMP (ACC COMP)	0			

Service Group	Fix/Var	No.	Name	Item name & (Description)	NTSC	Video	YUV	16:09
					Init Data			
RGB	FIX	1	AMUT	RGB POWER ON MUTE (RGB POWER ON MUTE)	0			
	FIX	2	PMUT	RGB Mute before OSD (RGB MUTE [EXCEPT OSD]	1			
	FIX	3	CORL	CUTOFF R L (R CUTOFF LOWER)	212			
	FIX	4	CORH	CUTOFF R H (R CUTOFF UPPER)	0			
	FIX	5	COGL	CUTOFF G L (G CUTOFF LOWER WHEN TEMP IS "COOL" AND "NEUTRAL"	197			
	FIX	6	COGH	CUTOFF G H (G CUTOFF LOWER WHEN TEMP IS "COOL" AND "NEUTRAL"	0			
	FIX	7	COBL	CUTOFF B L (B CUT OFF LOWER WHEN TEMP IS "COOL" AND "NEUTRAL"	176			
	FIX	8	COBH	CUTOFF B H (B CUT OFF LOWER WHEN TEMP IS "COOL" AND "NEUTRAL"	0			
	FIX	9	ABLS	ABL SEL (ABL SELECT)	0			
	FIX	10	ALSP	ACL SPEED (ACL SPEED)	0			
	FIX	11	ALRS	ACL SPE (ACL RECOVER SPEED)	2			
	FIX	12	ALAS	ACL ASPE (ACL ATACK SPEED)	9			
	FIX	13	ABLG	ABL GAIN (ABL GAIN)	5			
	FIX	14	ALS2	ACLASPE2 (ACL ATACK SPEED [2])	2			
	FIX	15	AKBM	AKB MODE (AKB MODE)	0			
	FIX	16	AKBP	AKB P[5:0] (AKB PULSE HEIGHT)	16			
	FIX	17	OSDL	OSD LIMIT (OSD LIMMIT SELECT)	0			
	FIX	18	UVIN	Y/U/V UVINV (U/V INVERT)	0			
	FIX	19	UVG	U/V GAIN (U/V OFFSET CANCELER ON)	0			
	FIX	20	UOFS	U IN OFFSET (U IN OFF SET)	15			
	FIX	21	VOFS	V IN OFFSET (V IN OFFSET)	12			
	FIX	22	AALG	ANA ACL GAIN (ANALOG ACL GAIN CONTROL)	0			
	FIX	23	AALS	ANA ACL ON (ANALOG ACL ON/OFF CONTROL)	1			
	FIX	24	UVDE	UV_DITHER_EN (UVIN DITHER ENABLE)	0	0	1	N/A
	FIX	25	UVDT	UV_DITHER_TEST (UVIN DITHER TEST)	0	0	6	N/A

Service Group	Fix/Var	No.	Name	Item name & (Description)	NTSC Init Data	Video	YUV	16:09
DEFD	FIX	1	HFFR	AFC FREE RUN (AFC1 FORCE FREE RUN)	0			
	FIX	2	HFUP	HFREE UP (H FREE RUN FREQUENCY UP [700 Hz]	0			
	FIX	3	JSWW	VJP WIDTH (JUMP PULSE WIDTH)	0			
	FIX	4	EWCL	V/EW DAC CLK CONTROL (EW/VRAMP DA CLOCK SELECT)	0	0	0	N/A
	FIX	5	XF0A	FREE RUN OFFSET (VCXO FREE RUN ADJUST)	0			
	FIX	6	BGST	BG START (BGP [FOR PLL] TIMING)	16	16	1	N/A
	FIX	7	XPHA	VCXO CTL (VXCO PHASE ADJUST)	10			
	FIX	8	HRMP	Ramp Slew Rate (AFC2 TIME CONSTANT)	3			
	FIX	9	RPLU	Ref Charge pump (REF PLL TIME CONSTANT)	3			
	FIX	10	RPLB	Ref VCO (REF PLL TIME CONSTANT)	1			
	FIX	11	XF0B	VCXO FREE RUN (VXCO Fo ADJUST)	0			
	FIX	12	RPLS	REF FB SW (REF VCO FB LOOP SELECT)	0			
	FIX	13	SSM	Sync Sepa Mask (SyncSepaMasking CONTROL)	0			
	FIX	14	VSAG	V-sag (V-SAG prevent ON)	0			
	FIX	15	AFC2	AFC2 Gain (AFC2 GAIN CONTROL)	3			
	FIX	16	VRFL	V RAMP FIL OFF (V RAMP FILTER SWITCHING OFF)	1			
	FIX	17	SSLP	LPY SYNC (LFP pre SYNC SEPA ON/OFF	1			
	FIX	18	XPLU	B PLL Change pump (ACP TIME CONSTANT)	1			
	FIX	19	8FSC	8FSC SEL (8fsCLK Skew OFF)	1	1	0	N/A
	FIX	20	4FS2	4FSC SEL2 (4fsCLK Skew OFF)	1	1	0	N/A
	FIX	21	CDM2	V_CD_MODE2 (V_LOGIC SW)	1			
	FIX	22	BGPC	Add. FTN BGP C (BGP C)	0			
	FIX	23	MHDL	Add. FTN BGP SEL (BBP SEL)	1			
	FIX	24	BFRE	V FREE (FORCE V FREE RUN)	0			
	FIX	25	HRPP	AFC2 RAMP POS (FRAMP RRAMP H OUT CONTROL RANGE	8			
	FIX	26	DSCK	CLOCK SEL (DS DAC CLK SW 2)	1	1	1	0
	FIX	27	VBHK	VBLK HALFKIL (V BLK HALF KILL)	0			
	FIX	28	VPW	V PLS WIDTH (V Pulse Wide)	1			
	FIX	29	DTH	D THRESHOLD LEVEL (DITHER THRESHOLD LEVEL CONTROL AT IIC AUTOD= ON	0			
	FIX	30	SLON	LPF SYNC ON (LPF SYNC ON)	1			

Service Group	Fix/Var	No.	Name	Item name & (Description)	NTSC Init Data	Video	YUV	16:09
DEFD	FIX	31	VSSW	SYNC SLICE LVL(V)_W (SYNC SLICE LEVEL [V] Wide Window	0			
	FIX	32	AF2S	AFC2_SEL (ADC2 TIMING SW)	0			
	FIX	33	VSL2	V_SYNC_LPF_2 (DIGITAL V_SINC_LPF [Fall])	0			
	FIX	34	VSL1	V_SYNC_LPF_1 (DIGITAL V_SINC_LPF [Rise])	1			
	FIX	35	VYUV	YUV VSIZE OFFSET (YUV V-SIZE OFFSET)	8			
	FIX	36	VYVP	YUV VPOS OFFSET (YUV V-POSITION OFFSET)	8			
	FIX	37	VYHS	YUV HSIZE OFFSET (YUV H-SIZE OFFSET)	8			
	FIX	38	VYHP	YUV HPOS OFFSET (YUV H-POSITION OFFSET)	7			
	FIX	39	VSHE	V-SHRINK MODE (V-SHRINK MODE for AV)	0			
	FIX	40	VYRB	YUV RBLK (YUV RBLK OFFSET)	7			
	FIX	41	VYLB	YUV LBLK (YUV LBLK OFFSET)	7			

Service Group	Fix/Var	No.	Name	Item name & (Description)	NTSC Init Data	Video	YUV	16:09
OTHER	FIX	1	PCLP	pedestal CLAMP ON/OFF (SYNC TIP/PEDESTAL CLAMP SELECT)	0			
	FIX	2	VRT	VRT Voltage (ADC REFERENCE [00:1.15Vpp 01:1.25 Vpp 10:1.35 Vpp 11:1.45 Vpp])	1			
	FIX	3	14HI	INV 14H CLK (4fsc [Skew] CLK POLARITY)	0	0	0	N/A
	FIX	4	14HD	14H CLK DLY (4fscCLK [Skew] CLK DELAY ADJUST)	0	0	0	N/A
	FIX	5	DSI	INV DS CLK (8fscCLK POLARITY)	0	0	0	N/A
	FIX	6	DSD	DS CLK DLY (8fscCLK DELAY ADJUST)	0	0	0	N/A
	FIX	7	ADCD	AD CLK DLY (ADC CLK DELAY ADJUSTO)	0	0	1	N/A
	FIX	8	4FSC	4FSC SW (AD/LOGIC CLK SWAP)	0			
	FIX	9	WSTH	WEAK_SIG_VTH (WEAK_SIGNAL VTH)	0			
	FIX	10	WSVA	WEAK SIG VIDEO ATT (WEAK SIGNAL VIDEO ATT)	0	0	0	N/A
	FIX	11	WSCA	WEAK SIG CHROMA ATT (WEAK SIGNAL CHROMA ATT)	0	0	0	N/A
	FIX	12	VREF	VREF_SEL (AD REFERENCE SELECT [VZ])	0			

Service Group	Fix/Var	No.	Name	Item name & (Description)	NTSC Init Data
OSD	FIX	1	HT	HT (HALF TONE LEVEL)	0
	FIX	2	OSLR	OSD LVL R (R OSD LEVEL)	25
	FIX	3	OSLG	OSD LVL G (G OSD LEVEL)	25
	FIX	4	OSDC	OSD COMP (OSD COMP)	0
	FIX	5	OSLB	OSD LVL B (B OSD LEVEL)	25

Service Group	Fix/Var	No.	Name	Item name & (Description)	NTSC Init Data
H/W AKB	FIX	1	HRIL	H/W AKB R INI DATA L (H/W AKB RED OUTPUT LOWER)	soft cont'l
	FIX	2	HRIH	H/W AKB R INI DATA H (H/W AKB RED OUTPUT UPPER)	soft cont'l
	FIX	3	HGIL	H/W AKB G INI DATA L (H/W AKB GREEN OUTPUT LOWER)	soft cont'l
	FIX	4	HGIH	H/W AKB G INI DATA H (H/W AKB GREEN OUTPUT UPPER)	soft cont'l
	FIX	5	HBIL	H/W AKB B INI DATA L (H/W AKB BLUE OUTPUT LOWER)	soft cont'l
	FIX	6	HBIH	H/W AKB B INI DATA H (H/W AKB BLUE OUTPUT UPPER)	soft cont'l
	FIX	7	HLM1	AKB_LIM1<7:0> (H/W AKB LIM1)	6
	FIX	8	HLM2	AKB_LIM2<7:0> (H/W AKB LIM2)	12
	FIX	9	HLM3	AKA_LIM3<7:0> (H/W AKB LIM3)	21
	FIX	10	HAD1	AKB_ADD1<7:0> (H/W AKB SPEED1)	2
	FIX	11	HAD2	AKB_ADD2<7:0> (H/W AKB SPEED2)	6
	FIX	12	HAKE	AKB_EN (H/W AKB MANUAL [MCU] / HARD	1
	FIX	13	HASP	AKB_SPEED (H/W AKB SPEED)	3
	FIX	14	HERL	AKB_SWERR<7:0> (H/W AKB ERROR DET THRESH)	40
	FIX	15	HLMC	AKB_ERRC<7:0> (H/W AKB ERROR DET TIME)	20
	FIX	16	HPWL	AKBSWPON<7:0> (H/W AKB POWER ON TRESH)	4
	FIX	17	HPWC	AKB_PWERRC (H/W AKB POWER ON TIME)	90
	FIX	18	HFMT	H/W AKB2 HOLD TIMER (H/W AKB2 HOLD TIMER (@ 100 MSEC) [0: No hold]	20
	FIX	19	SPMT	AKB POW ON MUTE EXIT (AKB POWER ON MUTE EXIT TIMMER)	120

Service Group	Fix/Var	No.	Name	Item name & (Description)	NTSC	
					29FA310	27/29FS120
AUDIO PROCE SSOR	VAR	1	SBAL	SBAL (SUB BALANCE)	4	4
	VAR	2	SBAS	SBAS (SUB BASS)	0	0
	VAR	3	STRE	STRE (SUB TREBLE)	6	0
	VAR	4	SRL	SRL (SURROUND LEVEL)	0	0
	VAR	5	BBOL	BBOL (SURROUND OFF-BBE LOW)	8	6
	VAR	6	BBOH	BBOH (SURROUND OFF-BBE HIGH)	4	5
	VAR	7	BBSL	BBSL (SIMULATE BBE LOW)	2	4
	VAR	8	BBSH	BBSH (SIMULATE BBE HIGH)	4	4
	VAR	9	BBGL	BBGL (WOW GAME BBE LOW)	6	0
	VAR	10	BBGH	BBGH (WOW GAME BBE HIGH)	4	0
	VAR	11	BBTL	BBTL (SRS BBE LOW)	0	6
	VAR	12	BBTH	BBTH (SRS BBE HIGH)	0	4
	VAR	13	BBDL	BBDL (Audio Processor Prologic BBE Low for DOLBY)	6	0
	VAR	14	BBDH	BBDH (Audio Processor Prologic BBE High for DOLBY)	4	0
	VAR	15	VFIX	VFIX (AUDIO OUTPUT FIX DATA)	0	243
	VAR	16	AGCL	AGCL (AGC LEVEL)	2	2
	VAR	17	VCOF	RF OFFSET DATA	9	9

Service Group	Fix/Var	No.	Name	Item name & (Description)	NTSC	
					29FA310	27/29FS120
AP2	VAR	1	BBEL	SUB AUDIO PROCESSOR PROLOGIC BBE LOW	9	0
	VAR	2	BBEH	SUB AUDIO PROCESSOR PROLOGIC BBE HIGH	9	0
	VAR	3	BBOL	SURROUND OFF-BBE LOW	9	0
	VAR	4	BBSL	SIMULATE BBE LOW	5	0
	VAR	5	BBGL	WOW GAME BBE LOW	10	0
	VAR	6	AGCL	SUB AUDIO PROCESSOR AGC LEVEL	2	0
	VAR	7	DDOF	DOLBY OFFSET DATA	15	0

Service Group	Fix/Var	No.	Name	Item name & (Description)	NTSC Init Data
MICROPROCESSOR	FIX	1	DISP	DISP (OSD HORIZONTAL OFFSET)	55
	FIX	2	CCHP	CCHP (FOR TILT DATA CALCULATION)	80
	FIX	3	HRLW	HRLW (LOW LIMIT OF H-PULSE COUNTING WINDOW [RF])	16
	FIX	4	HRHG	HRLG (HIGH LIMIT OF H-PULSE COUNTING WINDOW [RF])	64
	FIX	5	HSDT	HSDTCT (H-PULSE DETECTION [S-VIDEO])	8
	FIX	6	STPI	STPI (GRADUAL CONTRAST INCREASE STARTING LEVEL)	40
	FIX	7	RAPI	RAPI (GRADUAL CONTRAST INCREASE Vsync COUNTER)	10

Service Group	Fix/Var	No.	Name	Item name & (Description)	NTSC Init Data
Feature	VAR		ID0	Language related	81
	VAR		ID1	Video related	31
	VAR		ID2	Audio related	113
	VAR		ID3	Miscellaneous	130
	VAR		ID4	Miscellaneous	32
	VAR		ID5	Miscellaneous	24
	VAR		ID6	Miscellaneous	48
	VAR		ID7	Miscellaneous	69

4-5. ID MAP TABLE

Model	Destination	ID-0	ID-1	ID-2	ID-3	ID-4	ID-5	ID-6	ID-7
KV-27FA310	US	81	31	17	130	32	24	48	69
KV-27FA310	CND	81	31	17	130	32	24	48	69
KV-27FS120	US	89	31	17	34	0	24	0	5
KV-27FS120	CND	89	31	17	50	0	24	0	5
KV-29FS120	L NORTH	81	31	17	130	32	24	48	69
KV-29FS120	L SOUTH	81	31	17	130	32	24	48	69
KV-29FA310	L NORTH	81	31	113	130	32	24	48	69
KV-29FA310	L SOUTH	81	31	113	130	32	24	48	69

4-6. A BOARD ADJUSTMENTS

H. Frequency (Free Run) Check

1. Input a TV mode (RF) with no signal.
2. Connect a frequency counter to base of Q502 (TP-25 H. DRIVE) on the A Board.
3. Check H. Frequency for 15735 ± 200 Hz.

V. Frequency (Free Run) Check

1. Select video 1 with no signal input.
2. Set the conditions for a standard setting.
3. Connect the frequency counter to TP-27 (V OUT) or CN515 pin ⑥ (V DY+) and ground on the A Board .
4. Check that V. Frequency shows 60 ± 4 Hz.

Drive (SCON)

1. Input a color-bar signal and set the level to 75%.
2. Set in Pro mode + PICTURE MAX.
3. Activate the Service Adjustment Mode.
4. Set GON and BON items. Using ③ and ⑥ set each to the following values. Leave RON set to "1".

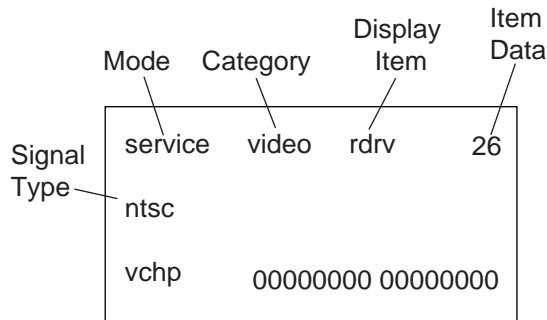

R ON: ON (1)
 G ON: OFF (0)
 B ON: OFF (0)

5. Connect an oscilloscope probe to CW Board, JW2704 (KR).
6. Select SCON with ① and ④.

7. Adjust the value of SCON with ③ and ⑥ for 87 ± 2Vpp.

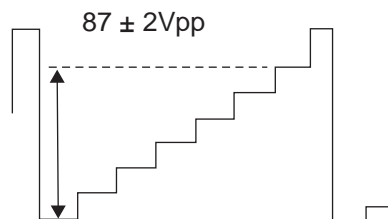

8. Reset GON and BON values to "1".

R ON: ON (1)
 G ON: ON (1)
 B ON: ON (1)

9. Press [MUTING] then [ENTER] to save into the memory.

Display Position Adjustment (DISP)

1. Input a color-bar signal.
2. Set to Service Adjustment Mode.
3. Select DISP with ① and ④.
4. Adjust values of DISP with ③ and ⑥ to adjust characters to the center.
5. Press [MUTING] then [ENTER] to save into the memory.
6. Check to see if the text is displayed on the screen.

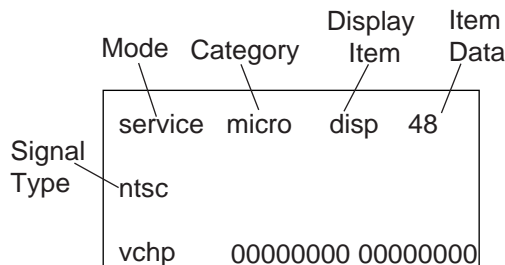

Sub Bright Adjustment (SBRT)

1. Input a monoscope signal.
2. Activate the Service Adjustment Mode.
3. Set the PICTURE and BRIGHTNESS to minimum.
4. Select the SBRT item with **1** and **4**.
5. Adjust the values of SBRT with **3** and **6** to obtain a faintly visible 20 IRE mark, after that increase +3 steps.
6. Press **MUTING** then **ENTER** to save into the memory.

Sub Hue, Sub Color Adjustment (SHUE, SCOL)

1. Input color-bar signal at 75%.
2. Activate the Service Adjustment Mode.
3. Set (PIC) to Max and (COL) to 50%.
4. Connect an oscilloscope probe to CW Board, JW7408 (Blue Out).
5. Select the SHUE and SCOL item with **1** and **4**.
6. While showing the SHUE item, adjust the waveform with **3** and **6** until the second and third bars show the same level ($V2 = V3 < 0.15Vp-p$). Set Sub Hue -2 Step.
7. While showing the SCOL item, adjust the waveform with **3** and **6** until the first and fourth bars show the same level ($V1 = V4 < 0.15Vp-p$). Set Sub Col +2 Step.

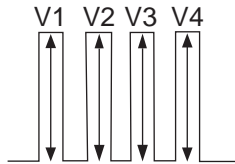

8. Press **MUTING** then **ENTER** to save into the memory.

V. Size Adjustment (VSIZ)

1. Input a crosshatch signal.
2. Activate the Service Adjustment Mode.
3. Select the VSIZ item with **1** and **4**.
4. Adjust value of VSIZ with **3** and **6** for the best vertical size.
5. Press **MUTING** then **ENTER** to save into the memory.

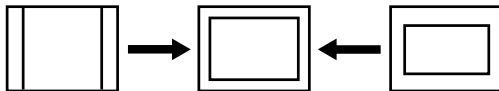

V. Center Adjustment (VPOS)

Perform this adjustment after performing H. Frequency (Free Run) Check.

1. Input a crosshatch signal.
2. Activate the Service Adjustment Mode.
3. Select the VPOS item with **1** and **4**.
4. Adjust value of VPOS with **3** and **6** for the best vertical center.
5. Press **MUTING** then **ENTER** to save into the memory.

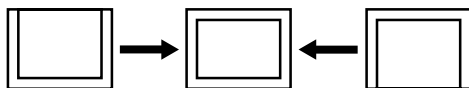

H. Center Adjustment (HPOS)

Perform this adjustment after performing H. Frequency (Free Run) Check.

1. Input a crosshatch signal.
2. Activate the Service Adjustment Mode.
3. Select the HPOS item with **1** and **4**.
4. Adjust the value of HPOS with **3** and **6** for the best horizontal center.
5. Press **MUTING** then **ENTER** to save into the memory.

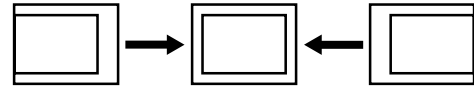

H. Size Adjustment (HSIZ)

1. Input a monoscope signal.
2. Activate the Service Adjustment Mode.
3. Select HSIZ with **1** and **4**.
4. Adjust with **3** and **6** for the best horizontal size.
5. Press **MUTING** then **ENTER** to save into the memory.

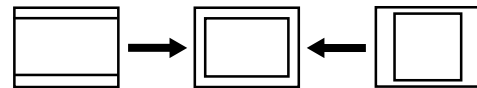

V. Linearity (VLIN), V. Correction (SCOR), PIN Amp (PAMP), and Horizontal Trapezoid (HTRP) Adjustments

1. Input a crosshatch signal.
2. Activate the Service Adjustment Mode.
3. Select VLIN, SCOR, PAMP, and HTRP with with **1** and **4**.
4. Adjust with **3** and **6** for the best horizontal size.
5. Press **MUTING** then **ENTER** to save into the memory.

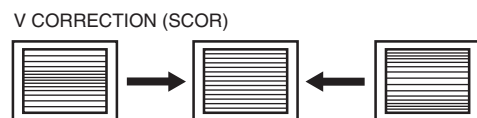
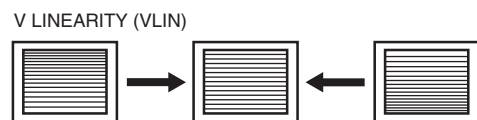

V. Angle (VANG), V. Bow (VBOW), Upper PIN (UPIN) and Low PIN (LPIN) Adjustments

1. Input a crosshatch signal.
2. Activate the Service Adjustment Mode.
3. Select VANG, VBOW, UPIN, and LPIN with **1** and **4**.
4. Adjust with **3** and **6** for the best picture.
5. Press **MUTING** then **ENTER** to save into the memory.

V ANGLE (VANG)

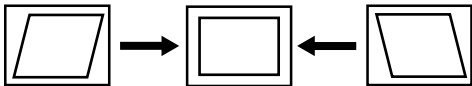

V BOW (VBOW)

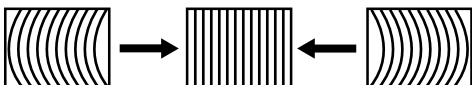

UPPER PIN (UPIN)

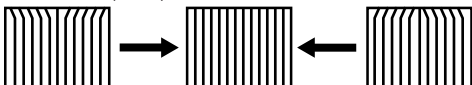

LOW PIN (LPIN)

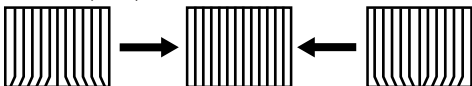

Service Adjustment Mode Memory

1. After completing all adjustments, press **0** then **ENTER**.

Read From Memory

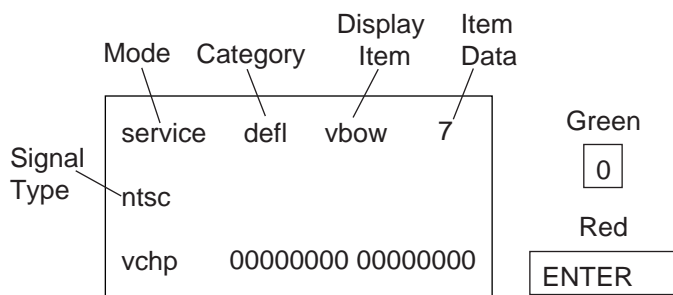

SECTION 5: DIAGRAMS

5-1. CIRCUIT BOARDS LOCATION

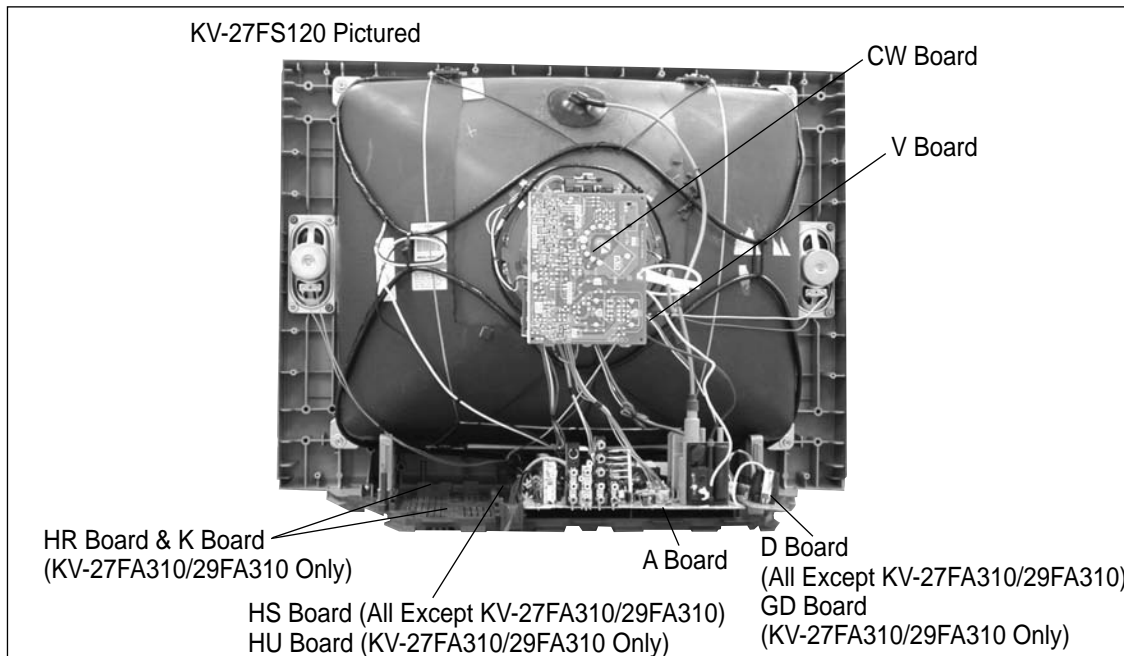

5-2. PRINTED WIRING BOARD AND SCHEMATIC DIAGRAM INFORMATION

All capacitors are in μF unless otherwise noted. pF : μF 50WV or less are not indicated except for electrolytics and tantalums.

All electrolytics are in 50V unless otherwise specified.

All resistors are in ohms. $k=1000$, $M=1000k$

Indication of resistance, which does not have one for rating electrical power, is as follows: Pitch : 5mm Rating electrical power :

$\frac{1}{4}$ W in resistance, $\frac{1}{10}$ W and $\frac{1}{8}$ W in chip resistance.

: nonflammable resistor.

: fusible resistor.

: internal component.

: panel designation and adjustment for repair.

: earth ground

: earth-chassis

All variable and adjustable resistors have characteristic curve B, unless otherwise noted.

Readings are taken with a color-bar signal input.

Readings are taken with a 10M digital multimeter.

Voltages are DC with respect to ground unless otherwise noted.

Voltage variations may be noted due to normal production tolerances.

All voltages are in V.

S : Measurement impossibility.

: B-line. (Actual measured value may be different).

: signal path. (RF)

Circled numbers are waveform references.

The components identified by shading and are critical for safety. Replace only with part number specified.

The symbol indicates a fast operating fuse and is displayed on the component side of the board. Replace only with fuse of the same rating as marked.

Les composants identifiés par un trame et une marque sont critiques pour la sécurité. Ne les remplacer que par une pièce portant le numéro spécifique.

Le symbole indique une fusible à action rapide. Doit être remplacé par une fusible de même valeur, comme marqué.

REFERENCE INFORMATION

RESISTOR

: RN METAL FILM
 : RC SOLID
 : FPRD NONFLAMMABLE CARBON
 : FUSE NONFLAMMABLE FUSIBLE
 : RW NONFLAMMABLE WIREWOUND
 : RS NONFLAMMABLE METAL OXIDE
 : RB NONFLAMMABLE CEMENT
 : ADJUSTMENT RESISTOR

COIL

: LF-8L MICRO INDUCTOR

CAPACITOR

: TA TANTALUM
 : PS STYROL
 : PP POLYPROPYLENE
 : PT MYLAR
 : MPS METALIZED POLYESTER
 : MPP METALIZED POLYPROPYLENE
 : ALB BIPOLAR
 : ALT HIGH TEMPERATURE
 : ALR HIGH RIPPLE

The components identified by in this basic schematic diagram have been carefully factory-selected for each set in order to satisfy regulations regarding X-ray radiation. Should replacement be necessary, replace only with the value originally used.

When replacing components identified by , make the necessary adjustments as indicated. If the results do not meet the specified value, change the component identified by and repeat the adjustment until the specified value is achieved.

(Refer to Section 3: Safety Related Adjustments on Page 17.)

When replacing the parts listed in the table below, it is important to perform the related adjustments.

Part Replaced (<input checked="" type="checkbox"/>)	Adjustment (<input checked="" type="checkbox"/>)
DY, T585, CRT, IC001, IC561, IC600, IC604, C506, C507, C508, C510, C511, C513, C514, L588, D566, D567, D568, PH602, R526, R564, R565, R566, R851, T510, T511.....A Board	HV HOLD-DOWN R564

5.3. BLOCK DIAGRAM AND SCHEMATICS

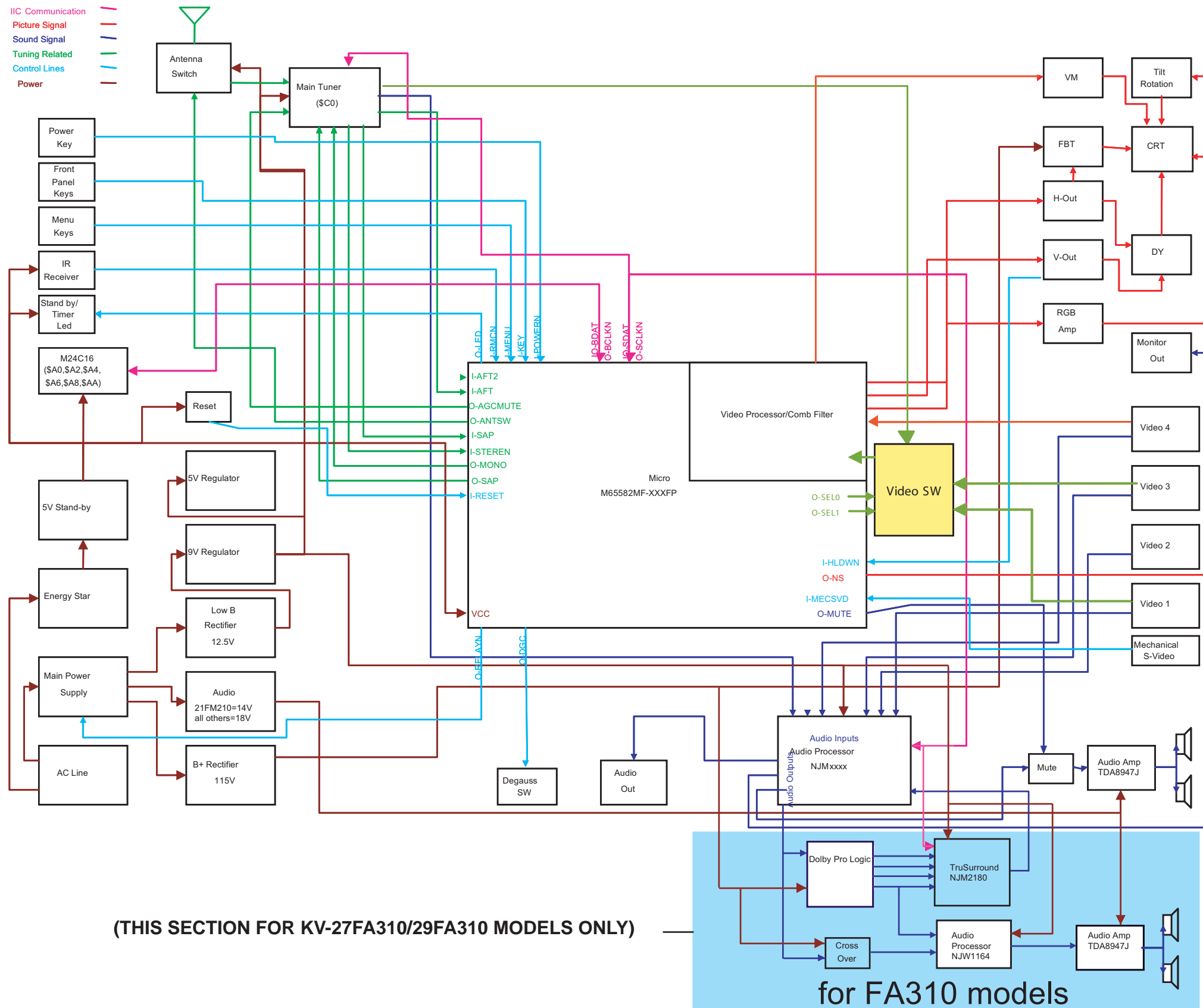

A BOARD SCHEMATIC DIAGRAM

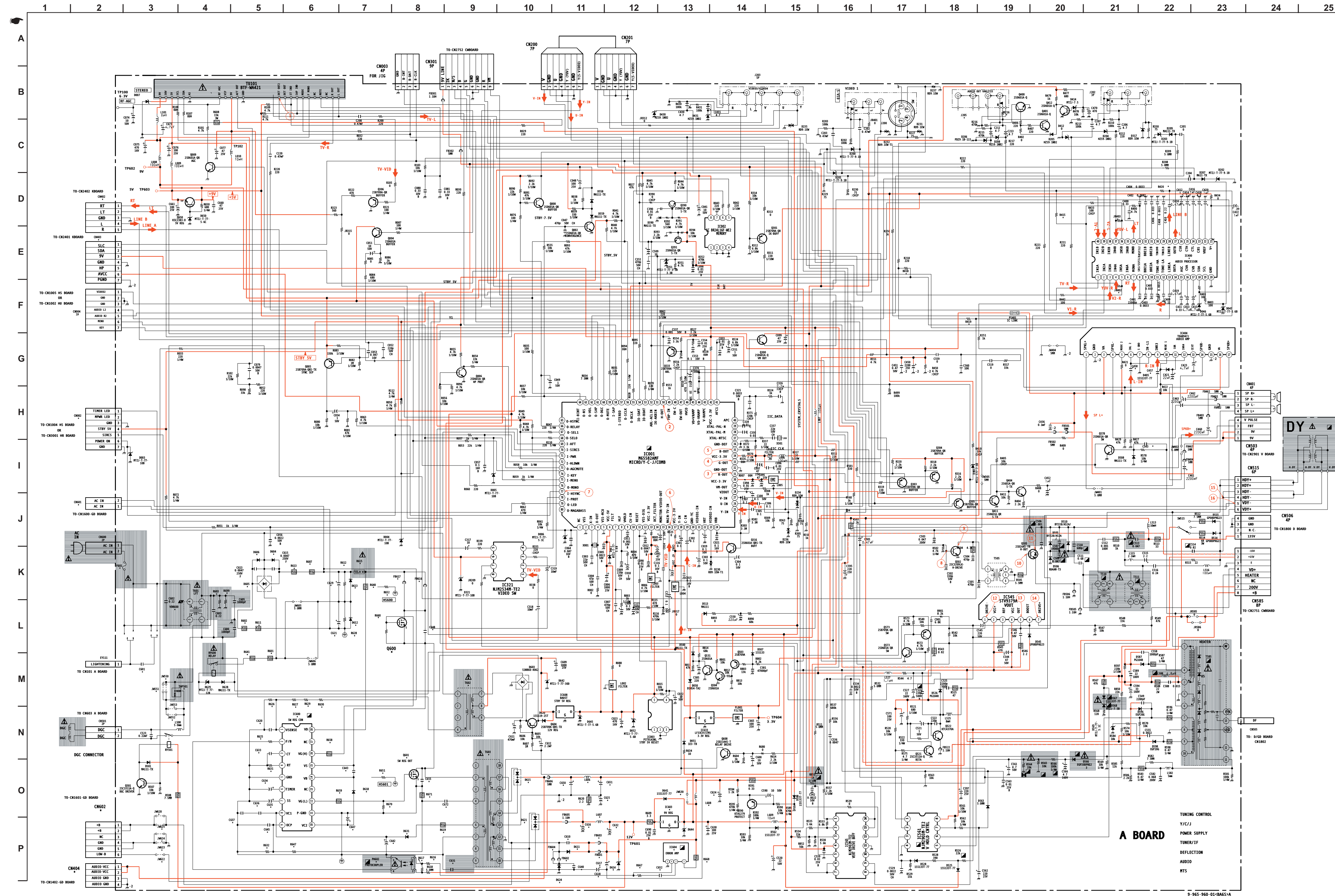

A BOARD WAVEFORMS

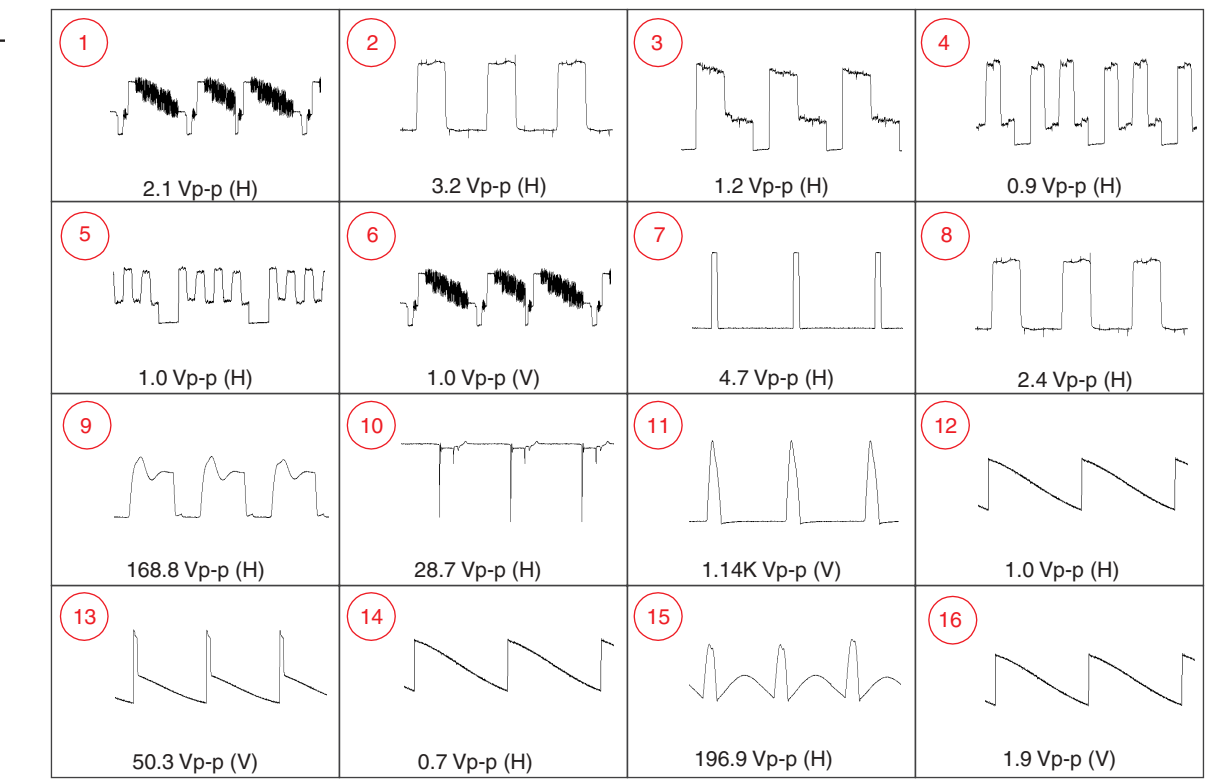

A BOARD IC VOLTAGE LIST

IC001	44	1.6	7	GND	25	3.9	IC561	IC603			
PIN	VOLT						PIN	VOLT	PIN	VOLT	
1	N/C	46	2.3	IC003	27	4.5	1	0.1	I	12.0	
2	GND	47	1.0	PIN	VOLT	28	4.5	2	3.4	G	GND
3	2.2	48	N/C	1	N/C	29	4.5	3	2.3	O	9.0
4	2.2	49	0.5	2	GND	30	4.5	4	GND	IC604	
5	GND	50	1.2	3	GND	31	4.5	5	9.2	PIN	VOLT
6	5.0	51	2.0	4	5.0	32	4.5	6	10.2	1	133.7
7	0.0	52	1.5	5	5.0	33	4.5	7	0.1	2	N/C
8	2.0	53	4.8	IC321	34	N/C	8	13.5	3	2.5	
9	0.3	54	4.8	PIN	VOLT	35	N/C	IC565	4	11.3	
10	2.1	55	4.8	1	4.5	36	N/C	PIN	VOLT	5	GND
11	5.0	56	4.8	2	0.3	37	4.5	1	3.4	IC608	
12	GND	57	N/C	3	4.5	38	4.5	2	3.4	PIN	VOLT
13	3.3	58	5.2	4	0.4	39	4.5	3	2.1	I	11.0
14	3.1	59	0.0	5	4.5	40	4.5	4	9.0	O	5.0
15	1.0	60	0.0	6	9.0	IC404	5	1.0	G	GND	
16	1.5	61	0.0	7	4.4	PIN	VOLT	6	1.0	IC633	
17	3.3	62	0.0	8	GND	1	8.3	7	1.0	PIN	VOLT
18	0.5	63	1.4	IC400	2	GND	8	1.6	I	9.0	
19	1.1	64	4.9	PIN	VOLT	3	19.6	9	1.6	G	GND
20	GND	65	4.9	1	4.5	4	8.3	10	1.6	O	3.3
21	0.5	66	0.0	2	4.5	5	19.6	11	GND		
22	1.7	67	0.1	3	4.5	6	3.2	12	1.6		
23	0.5	68	0.1	4	4.5	7	0.0	13	1.6		
24	0.5	69	2.4	5	N/C	8	0.0	14	1.6		
25	0.5	70	5.0	6	N/C	9	3.2	IC600			
26	0.0	71	5.0	7	N/C	10	9.1	PIN	VOLT		
27	0.0	72	0.1	8	4.5	11	9.7	1	2.5		
28	2.1	73	0.0	9	4.5	12	3.2	2	1.8		
29	2.7	74	5.0	10	4.5	13	3.3	3	2.2		
30	3.3	75	5.0	11	4.5	14	8.3	4	2.5		
31	2.9	76	5.0	12	4.5	15	GND	5	GND		
32	GND	77	0.1	13	4.5	16	19.6	6	0.0		
33	2.8	78	0.0	14	4.5	17	8.3	7	4.0		
34	3.3	79	4.9	15	0.6	IC545	8	17.2			
35	2.9	80	4.9	16	3.5	PIN	VOLT	9	GND		
36	GND	IC002	17	3.5	1	0.7	10	10.4			
37	1.8	PIN	VOLT	18	4.8	2	13.5	11	0.0		
38	0.0	1	GND	19	4.8	3	-12.2	12	4.6		
39	0.1	2	GND	20	GND	4	-13.3	13	N/C		
40	2.0	3	GND	21	9	5	0.2	14	163.6		
41	1.6	4	GND	22	4.5	6	13.8	15	153.5		
42	3.3	5	4.8	23	3.8	7	0.7	16	157.6		
43	N/C	6	4.8	24	3.9			17	N/C		
								18	340.0		

A BOARD TRANSISTOR VOLTAGE LIST

Q002	B	C	E	Q411	B	C	E	Q600	D	G	S
Q004	3.8	9.0	4.4	Q412	0.1	0.1	GND	Q601	155.0	4.9	0.0
Q005	5.1	0.8	5.0	Q501	0.0	14.3	GND				
Q006	0.0	0.0	GND	Q502	0.0	74.1	GND				
Q008	0.0	0.0	2.6	GND	Q503	2.9	0.0	9.0			
Q009	0.0	5.2	GND	Q504	0.0	0.0	GND				
Q300	1.8	9.0	2.4	Q505	0.0	131.8	0.0				
Q301	3.6	2.1	3.6	Q521	0.0	3.8	GND				
Q303	3.6	GND	2.8	Q522	0.1	-2.1	0.0				
Q304	3.6	GND	2.9	Q531	0.0	0.0	GND				
Q305	3.6	GND	3.0	Q533	1.5	GND	1.5				
Q306	5.5	GND	4.9	Q572	0.0	2.6	GND				
Q316	0.0	3.3	0.0	Q573	2.6	0.0	2.6				
Q390	0.8	1.5	1.9	Q578	0.0	0.5	GND				
Q391	0.6	3.3	1.5	Q590	133.7	0.0	134.2				
Q400	0.0	0.1	GND	Q604	30.6	11.6	30.2				
Q401	0.0	0.1	GND	Q608	0.0	6.7	GND				
Q404	0.0	0.0	GND	Q650	5.8	9.0	5.0				

All voltages are in V.

A [TUNING CONTROL, Y/CI, POWER SUPPLY, TUNER/IF, DEFLECTION, AUDIO, MTS]

COMPONENT SIDE

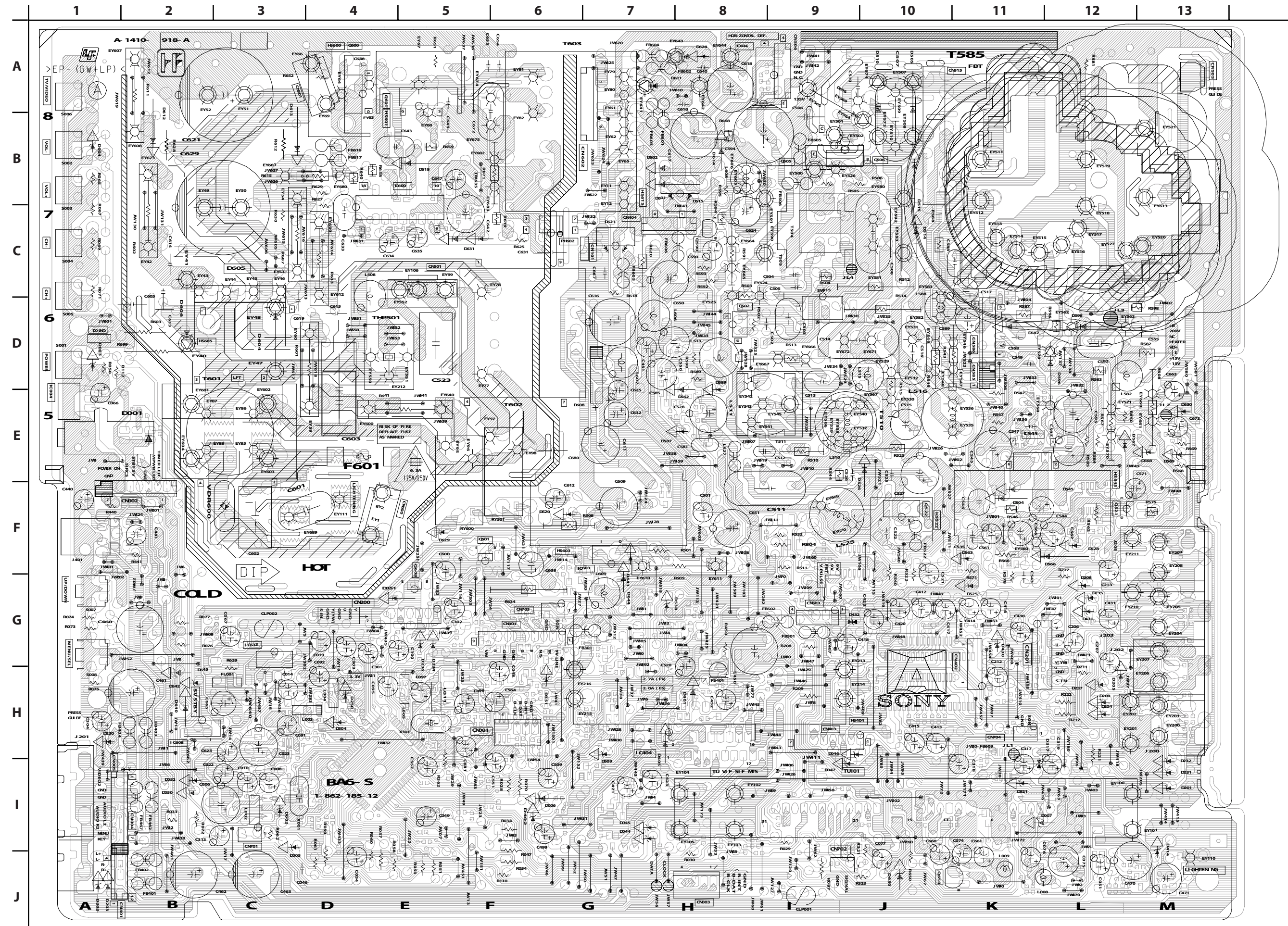

A [TUNING CONTROL, Y/CI, POWER SUPPLY, TUNER/IF, DEFLECTION, AUDIO, MTS]

CONDUCTOR SIDE

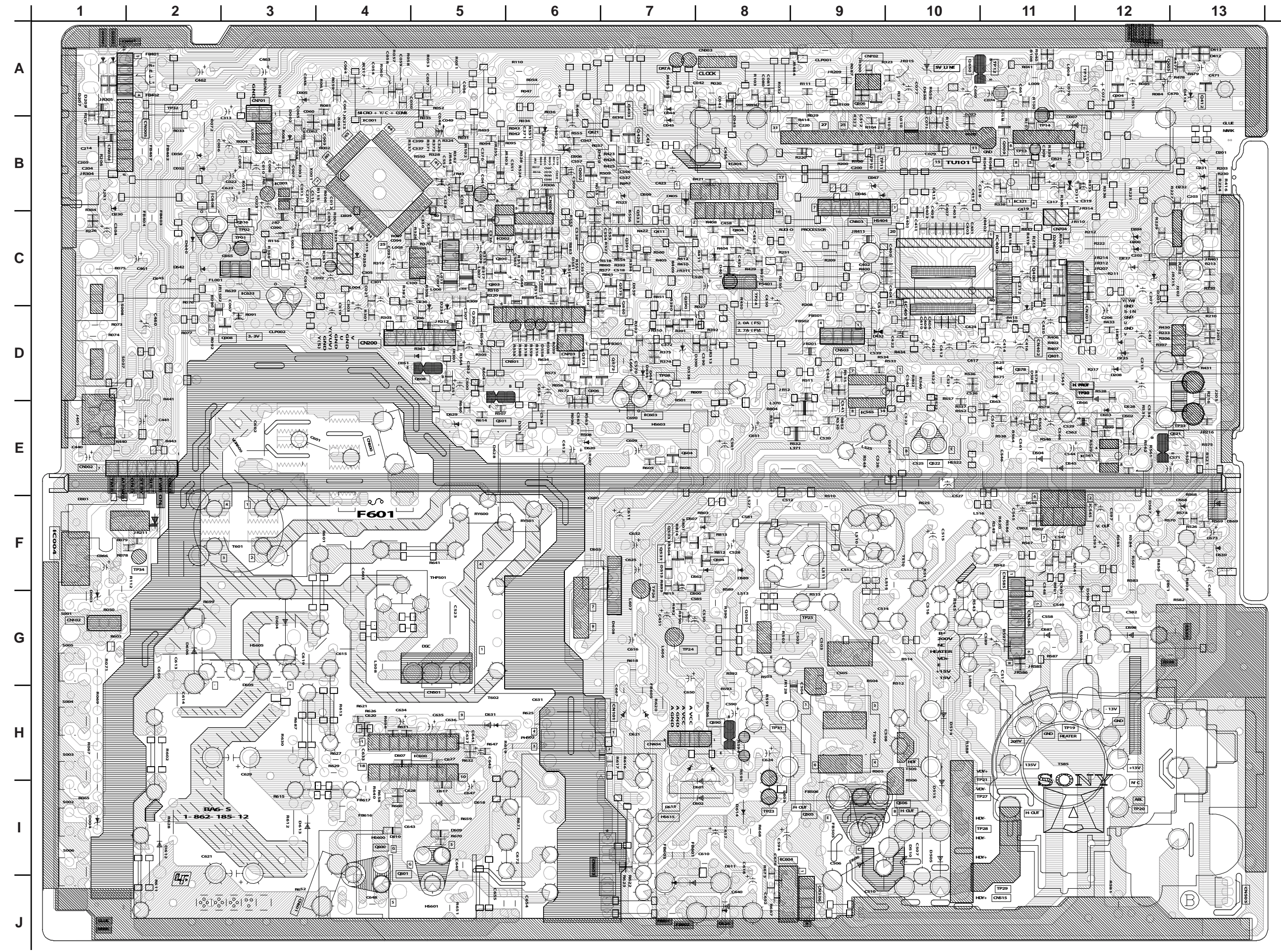

A BOARD LOCATOR LIST CONDUCTOR SIDE

DIODE	D230	C1	D507	F8	D603	F7	IC002	C5	Q303	C5	Q522	E10		
D002	B3	D231	B13	D508	D11	D604	G3	IC003	B3	Q304	D6	Q531	F7	
D003	G1	D232	B13	D510	I10	D605	G3	IC321	B11	Q305	C6	Q533	C7	
D004	I1	D234	D5	D513	F7	D606	G3	IC400	C10	Q306	B9	Q572	D7	
D005	A3	D235	D12	D514	H10	D611	J8	IC401	C10	Q316	C3	Q573	D6	
D006	B6	D236	D5	D515	H10	D612	I2	IC404	B8	Q390	D7	Q578	D11	
D007	B11	D237	C12	D525	D11	D613	I4	IC545	F11	Q391	C7	Q590	H8	
D045	B7	D317	B11	D526	E10	D614	I8	IC561	E12	Q400	C11	Q600	I4	
D046	B9	D321	B11	DIODE			D615	I7	IC565	E9	Q401	D11	Q601	I5
D047	B9	D351	C6	D528	E12	D618	I5	IC600	H5	Q403	A7	Q604	E8	
D050	B2	D390	D8	D545	E11	D620	E6	IC603	D7	Q404	C8	Q608	D5	
D051	D4	D401	C8	D558	D6	D621	H7	IC604	I9	Q411	C7	Q650	A10	
D052	B2	D405	B7	D559	C7	D624	J8	IC608	B2	Q412	A13	Q860	C7	
D200	C12	D412	A13	D562	F8	D628	E5	IC633	C3	Q420	B7			
D201	B13	D414	A13	D563	D11	D629	E5	TRANSISTORS			Q421	B6		
D202	A1	D420	B6	D566	E12	D631	H6	Q002	B6	Q501	E6			
D203	A1	D430	D11	D567	F12	D641	D7	Q004	A12	Q502	G8			
D204	B12	D431	D12	D568	F13	D642	C2	Q005	A12	Q503	F7			
D205	C12	D432	D9	D569	F13	D644	D7	Q006	D7	Q504	F8			
D206	C11	D500	G7	D587	G11	D645	C2	Q008	D3	Q505	I9			
D207	A11	D501	E6	D589	F8	D650	B10	Q009	B11	Q506	I10			
D208	D12	D505	I10	D596	G12	IC		Q300	D5	Q519	C7			
D209	A1	D506	I9	D598	G12	IC001	B4	Q301	C6	Q521	E12			

CW BOARD SCHEMATIC DIAGRAM

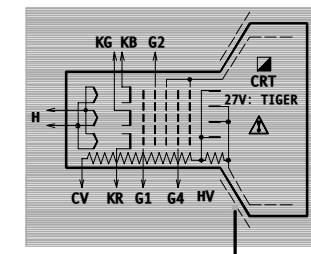
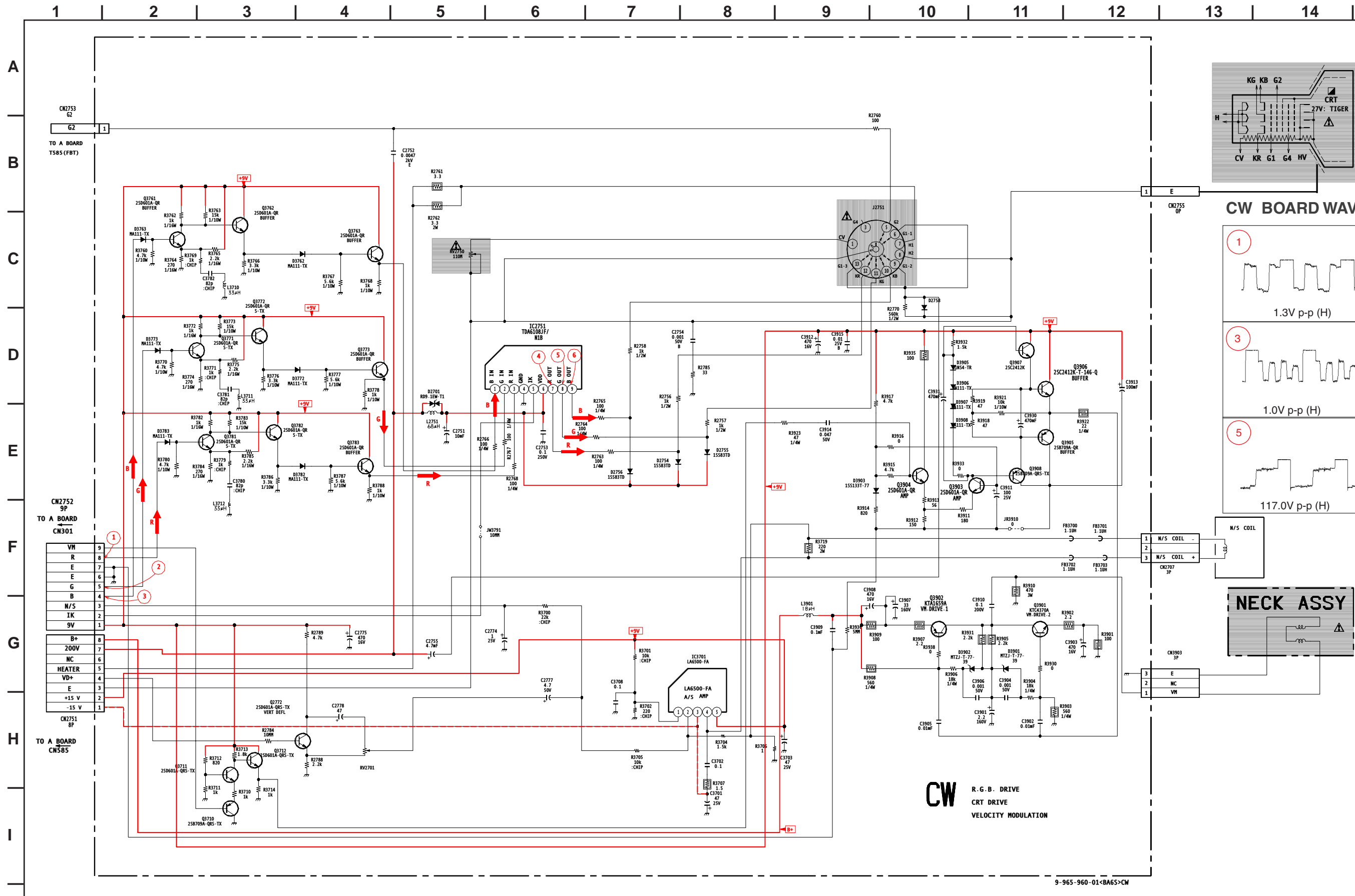

CW BOARD WAVEFORMS

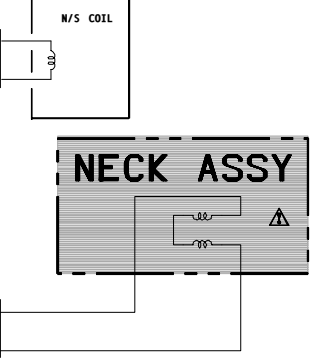
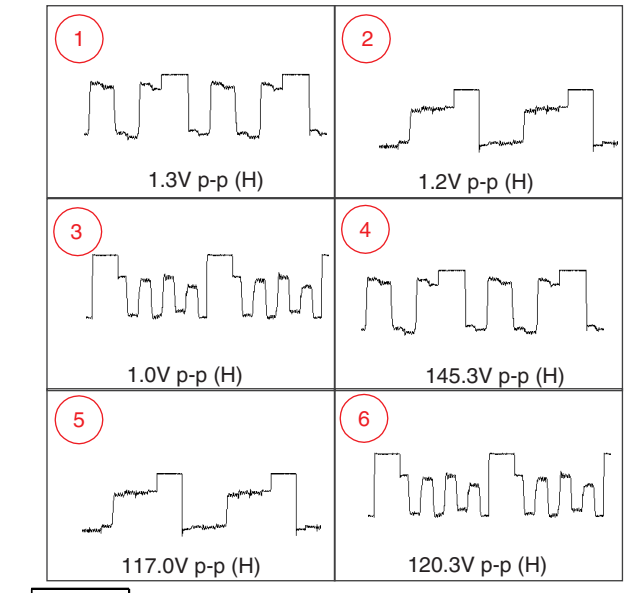

CW R.G.B. DRIVE
CRT DRIVE
VELOCITY MODULATION

CW [RGB DRIVE, CRT DRIVE, VELOCITY MODULATION]

D [DEFLECTION] (ALL EXCEPT KV-27FA310/29FA310)

HS [IR DETECTOR, FRONT VIDEO2] (ALL EXCEPT KV-27FA310/29FA310)

V [VELOCITY MODULATION]

COMPONENT SIDE

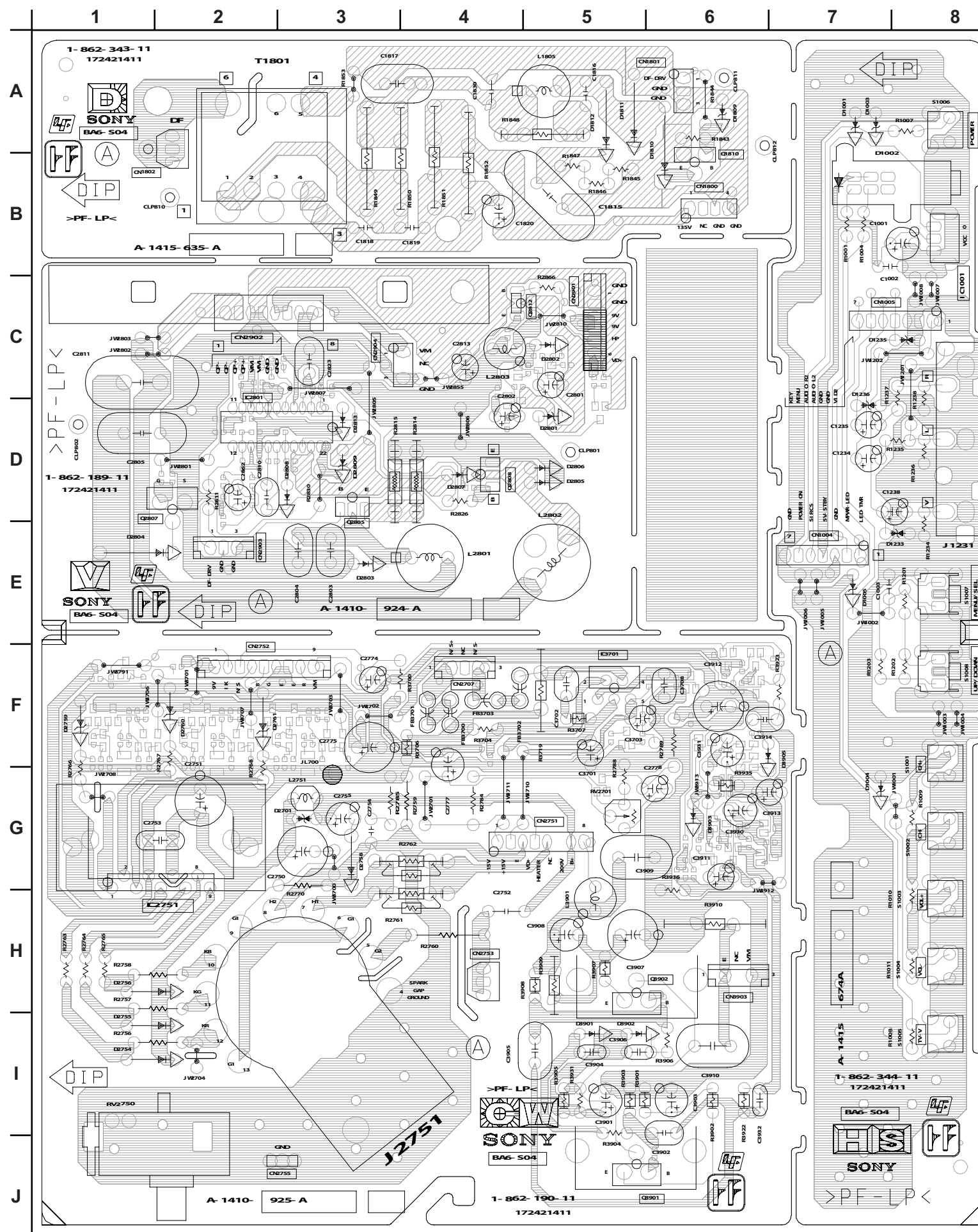

CW [RGB DRIVE, CRT DRIVE, VELOCITY MODULATION]

D [DEFLECTION] (ALL EXCEPT KV-27FA310/29FA310)

HS [IR DETECTOR, FRONT VIDEO2] (ALL EXCEPT KV-27FA310/29FA310)

V [VELOCITY MODULATION]

CONDUCTOR SIDE

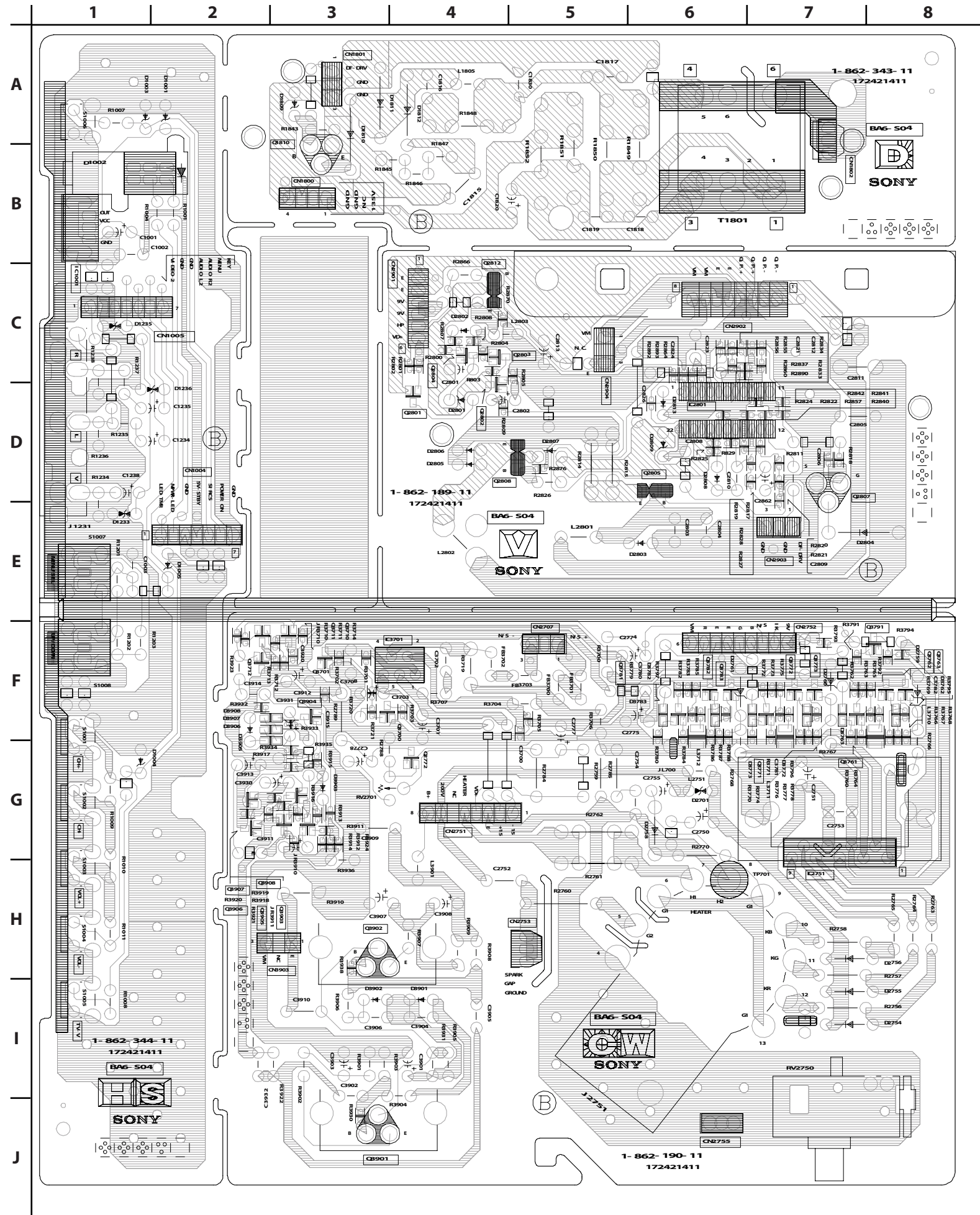

GD BOARD SCHEMATIC DIAGRAM (KV-27FA310/29FA310 ONLY)

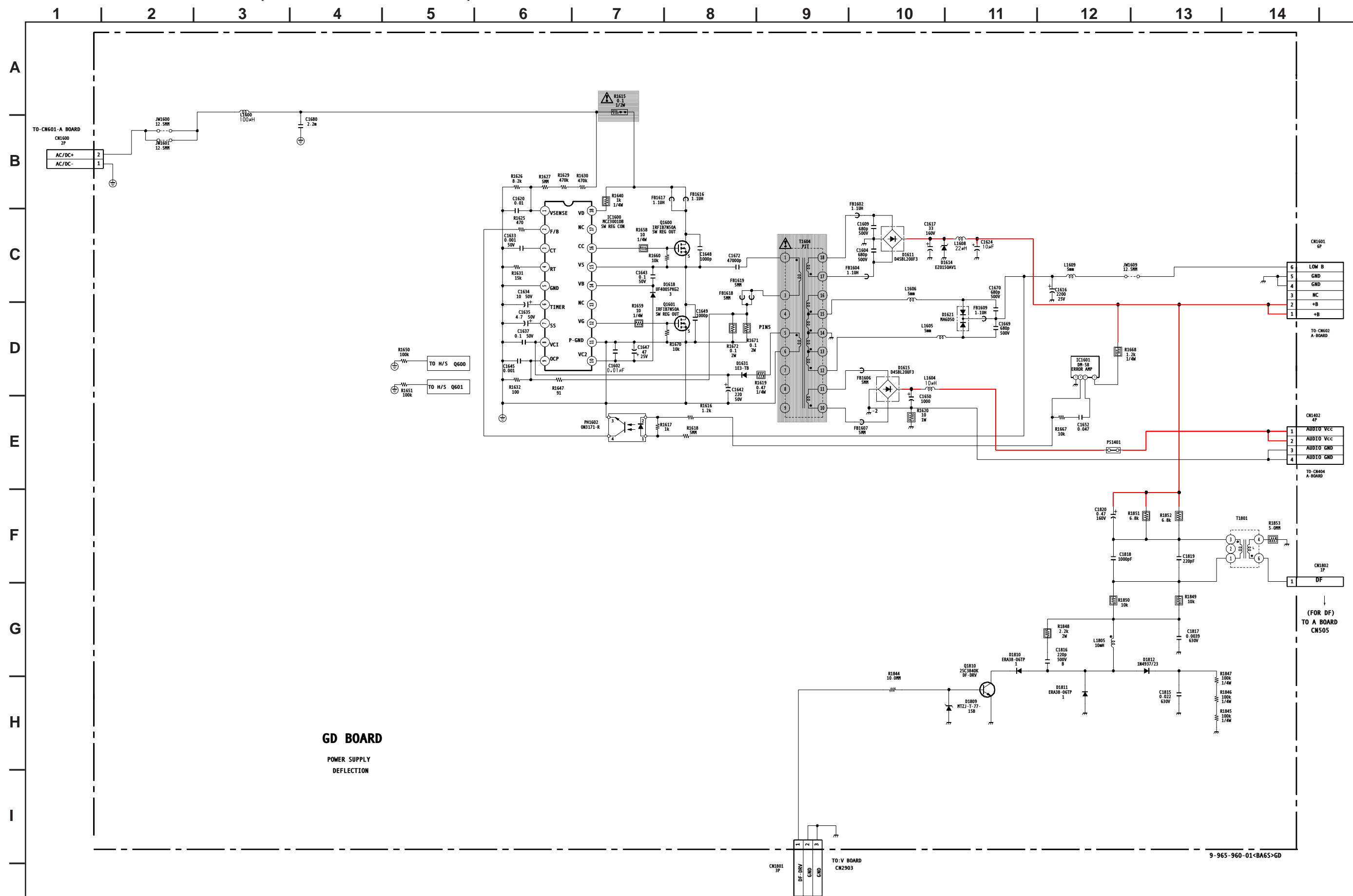

GD BOARD IC VOLTAGE LIST

IC1600		IC1601	
PIN	VOLT	PIN	VOLT
1	2.5	1	133.7
2	1.8	2	N/C
3	2.2	3	2.5
4	2.5	4	11.3
5	GND	5	GND
6	0.0	All voltages are in V.	
7	4.0		
8	17.2		
9	GND		
10	10.4		
11	0.0		
12	4.6		
13	N/C		
14	163.6		
15	153.5		
16	157.6		
17	N/C		
18	340.0		

GD BOARD TRANSISTOR VOLTAGE LIST

	D	G	S
Q1600	313.0	160.0	156.0
Q1601	155.0	4.9	0.0

	B	C	E
Q1810	0.0	59.7	GND

All voltages are in V.



COMPONENT SIDE (KV-27FA310/29FA310 ONLY)

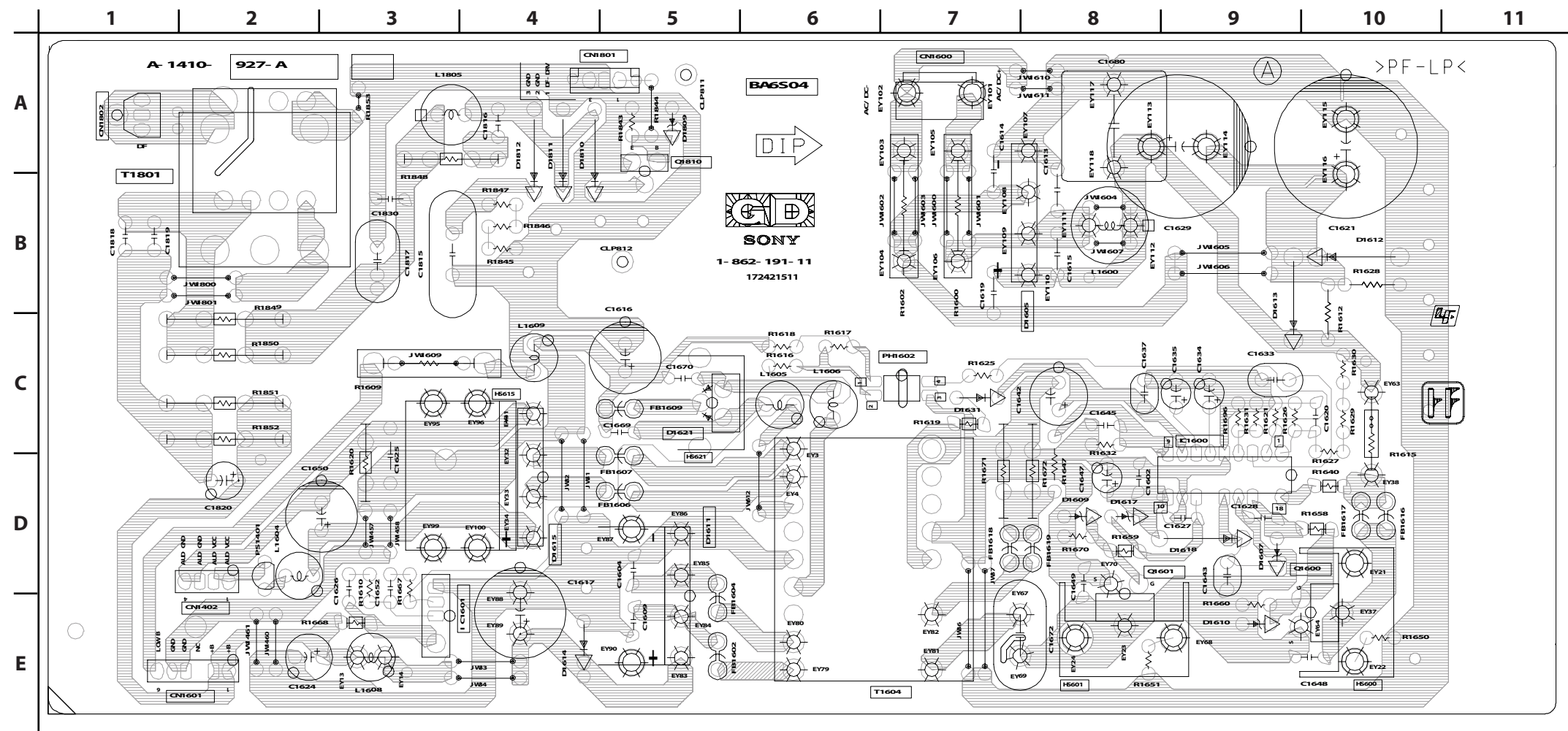



CONDUCTOR SIDE (KV-27FA310/29FA310 ONLY)

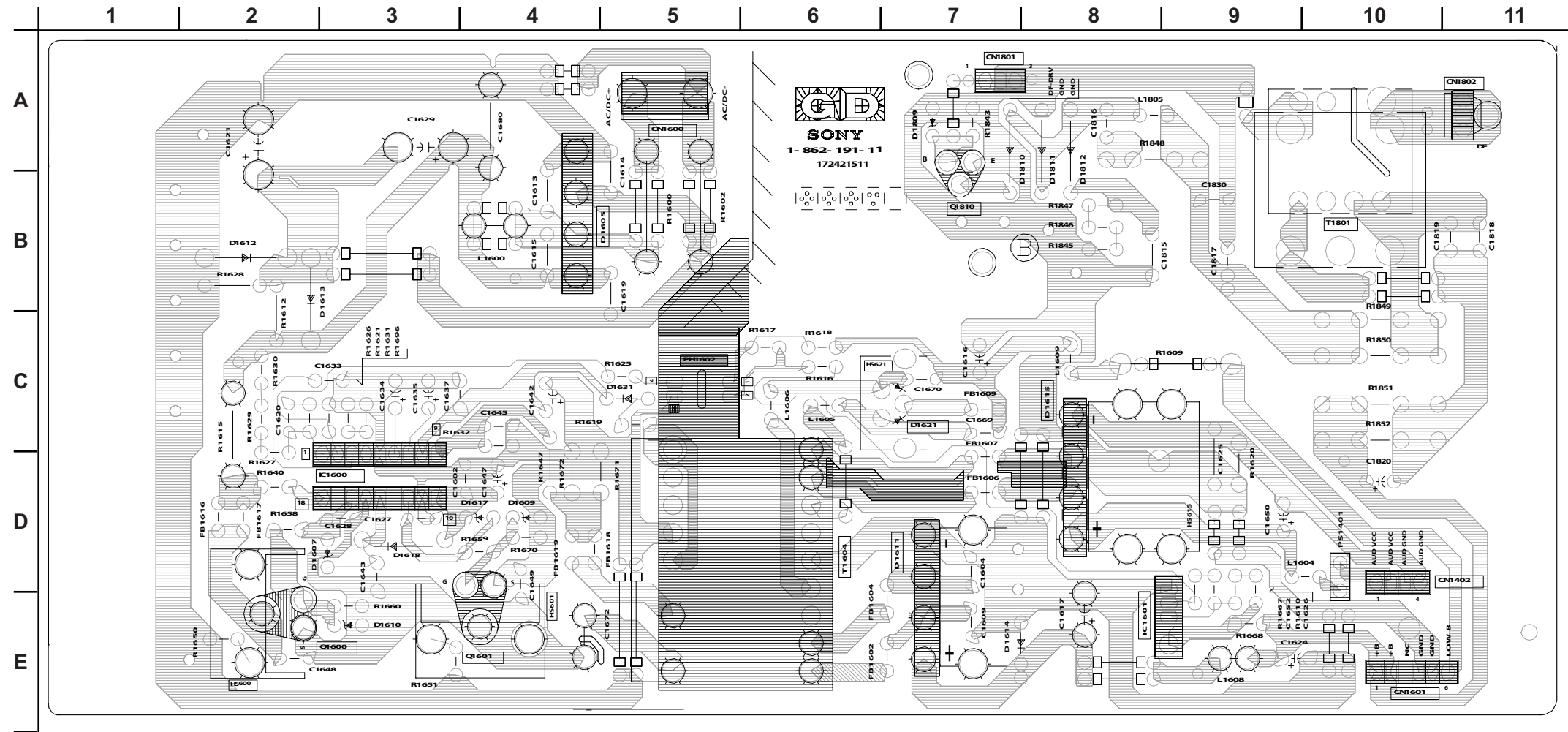

HR BOARD SCHEMATIC DIAGRAM (KV-27FA310/29FA310 ONLY)

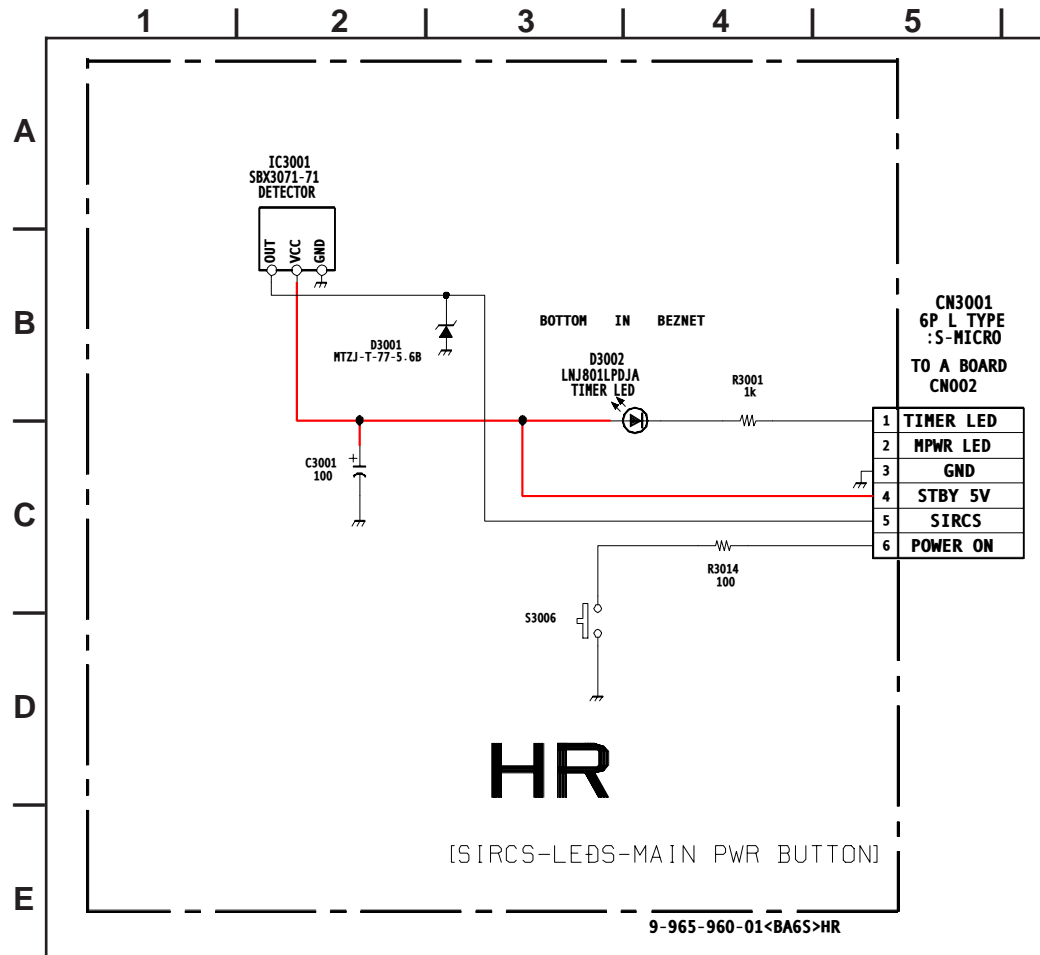

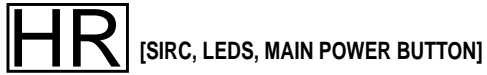

COMPONENT SIDE (KV-27FA310/29FA310 ONLY)

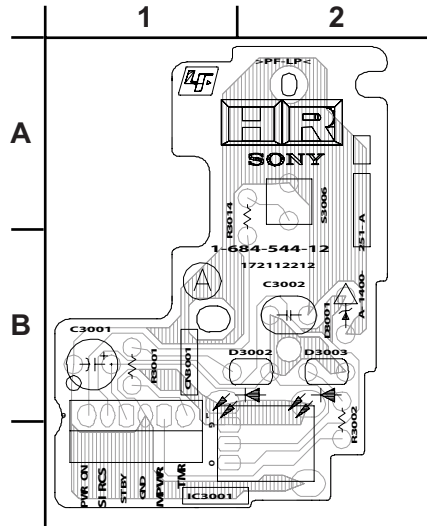

CONDUCTOR SIDE (KV-27FA310/29FA310 ONLY)

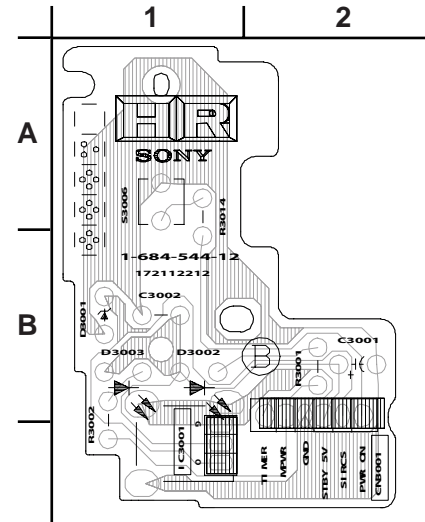

HU BOARD SCHEMATIC DIAGRAM (KV-27FA310/29FA310 ONLY)

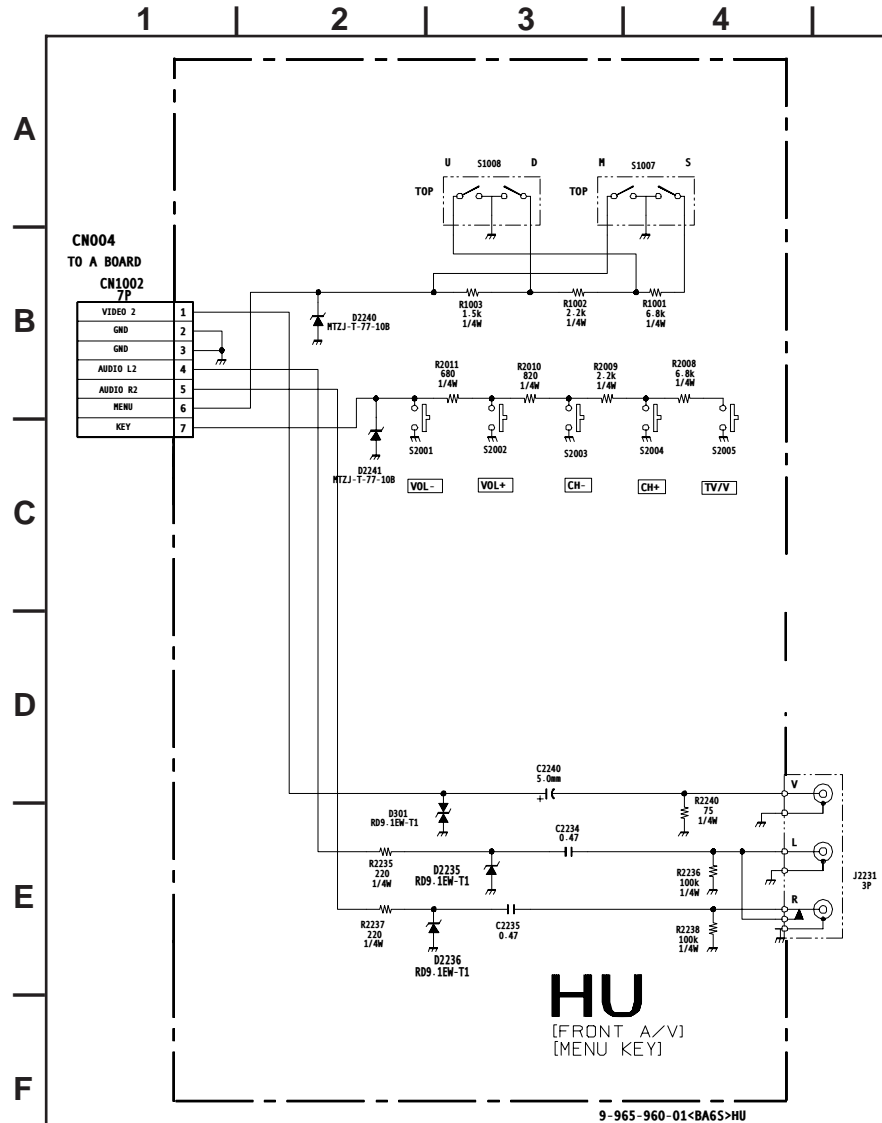



[FRONT AV, MENU KEY]

CONDUCTOR SIDE (KV-27FA310/29FA310 ONLY)

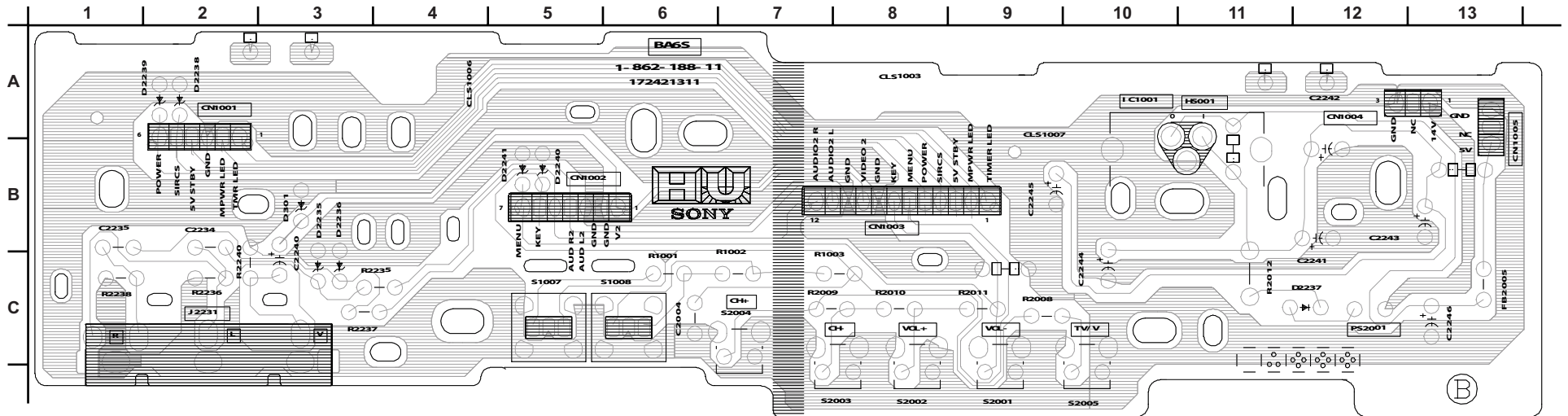

K BOARD SCHEMATIC DIAGRAM (KV-27FA310/29FA310 ONLY)

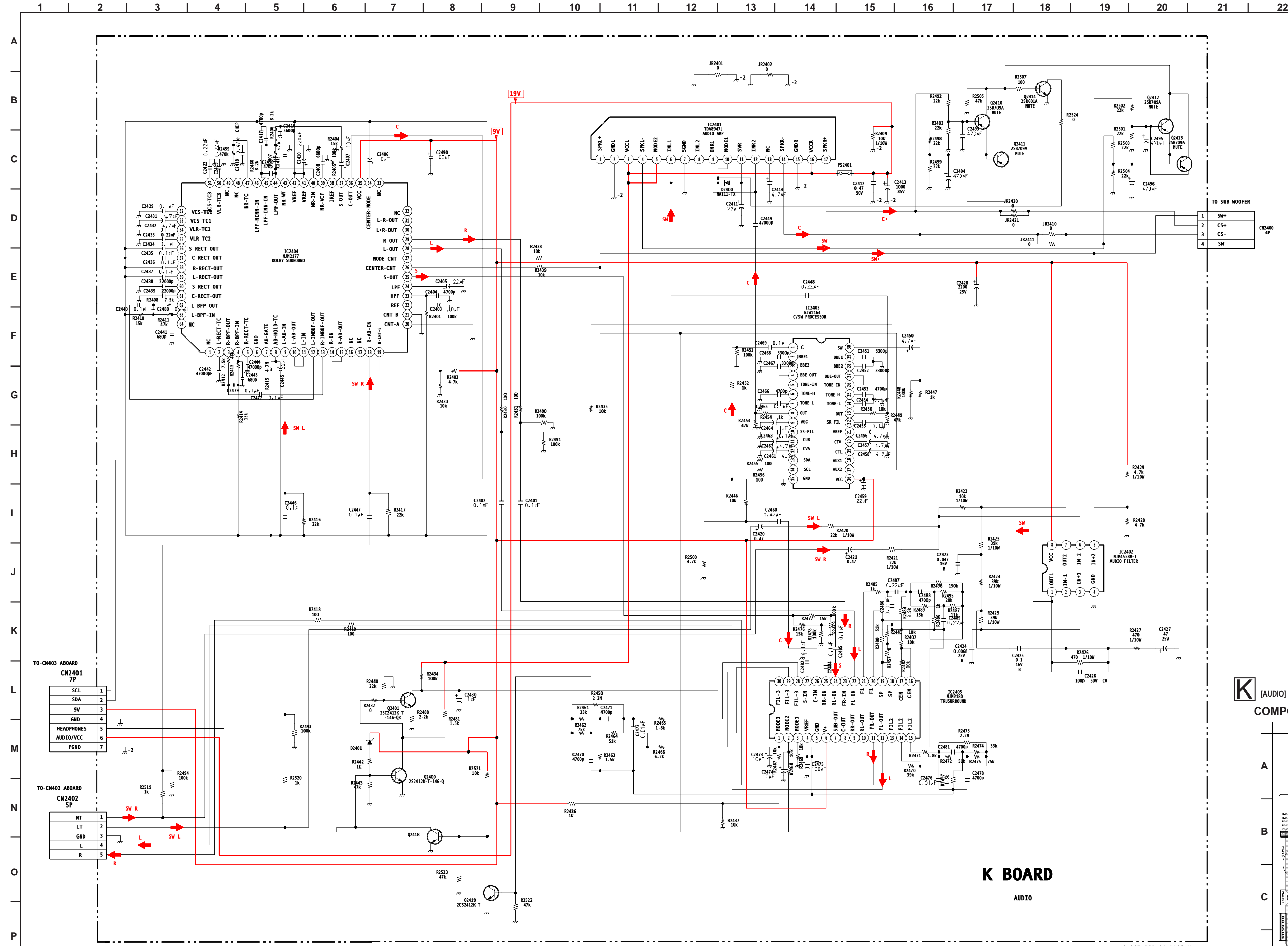

K BOARD IC VOLTAGE LIST

IC2401		IC2403		28	4.5	25	4.0	54	4.0	17	4.5	
PIN	VOLT	PIN	VOLT	IC2404	PIN	VOLT	IC2405	PIN	VOLT	IC2405	PIN	VOLT
1	8.3	1	4.5	30	4.5	27	4.37	56	4.0	19	4.5	
2	GND	2	4.5	28	4.0	57	4.0	20	4.5			
3	19.6	3	4.5	29	4.0	58	4.0	21	4.5			
4	8.3	4	4.5	1	n/c	30	n/c	59	4.0	22	4.5	
5	19.6	5	4.5	2	4.0	31	n/c	60	4.0	23	4.5	
6	3.2	6	4.5	3	4.0	32	n/c	61	4.0	24	4.5	
7	GND	7	4.5	4	4.0	33	n/c	62	4.0	25	4.5	
8	0.0	8	4.5	5	4.0	34	4.0	63	4.0	26	4.5	
9	3.2	9	1.0	6	GND	35	9.0	64	n/c	27	4.5	
10	9.1	10	4.5	7	n/c	36	4.0					
11	9.7	11	3.4	8	3.8	37	4.0					
12	3.2	12	3.3	9	4.0	38	1.45	1	7.7	30	4.5	
13	3.3	13	4.5	10	4.0	39	4.0	2	4.6			
14	8.3	14	4.5	11	4.0	40	4.0	3	0.0			
15	GND	15	GND	12	4.0	41	4.0	4	4.5			
16	19.6	16	9.0	13	4.0	42	4.0	5	0.0			
17	8.3	17	4.9	14	4.0	43	4.0	6	9.0			
IC2402		18	0.0	15	4.0	44	4.0	7	n/c			
PIN		19	3.88	16	n/c	45	4.0	8	n/c			
PIN		20	4.5	17	n/c	46	4.0	9	n/c			
PIN		21	4.5	18	4.0	47	0.0	10	n/c			
PIN		22	4.5	19	5.8	48	n/c	11	4.5			
PIN		23	4.5	20	GND	49	n/c	12	4.5			
PIN		24	4.5	21	GND	50	4.0	13	4.5			
PIN		25	4.5	22	4.0	51	3.0	14	4.5			
PIN		26	4.5	23	2.65	52	3.0	15	4.5			
PIN		27	4.5	24	4.0	53	3.0	16	4.5			

All voltages are in V.

K BOARD TRANSISTOR VOLTAGE LIST

	B	C	E
Q2400	0.7	0.0	GND
Q2401	0.0	17.9	0.0
Q2410	4.8	0.0	4.8
Q2411	4.8	0.0	4.8
Q2412	4.8	0.0	4.9
Q2413	4.8	0.0	4.9
Q2414	0.0	0.2	GND
Q2418	0.0	0.7	GND
Q2419	0.0	0.0	GND

All voltages are in V.

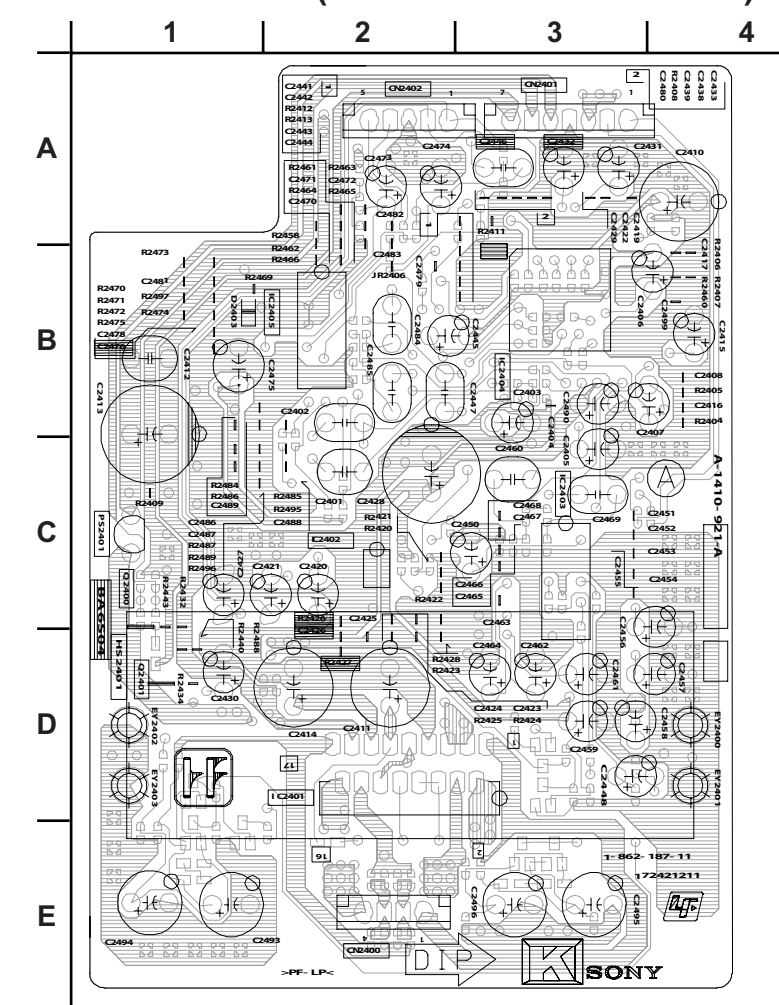

[AUDIO] COMPONENT SIDE (KV-27FA310/29FA310 ONLY)

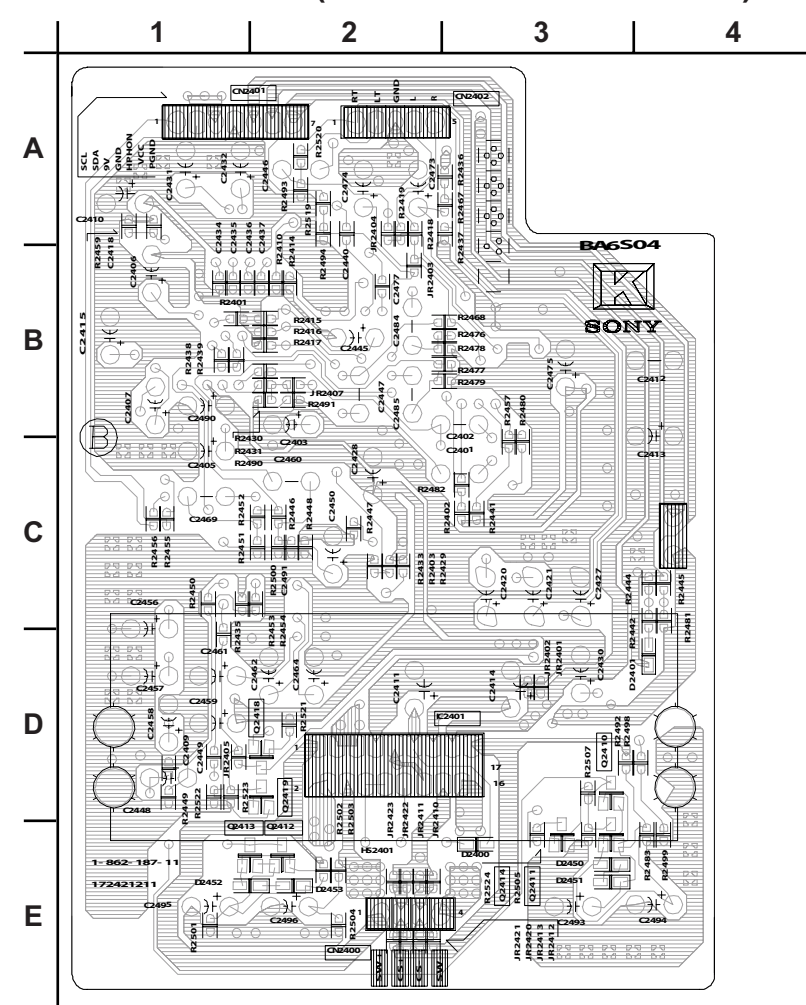

[AUDIO] CONDUCTOR SIDE (KV-27FA310/29FA310 ONLY)

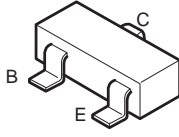
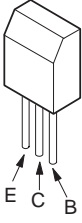
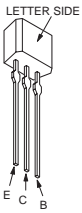
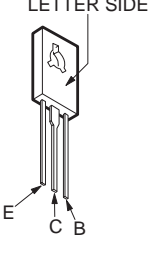
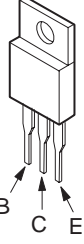

5-4. SEMICONDUCTORS

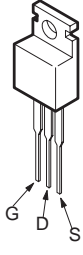
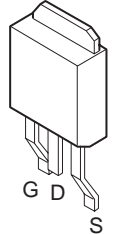
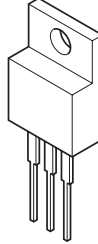
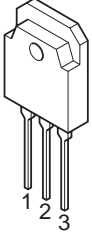
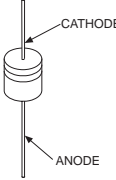
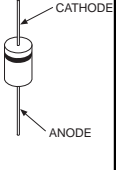
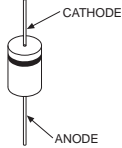
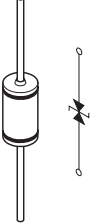
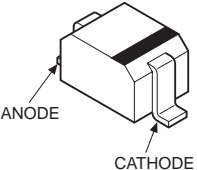
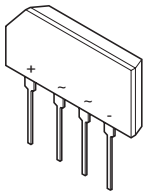
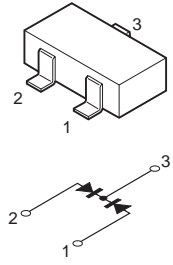
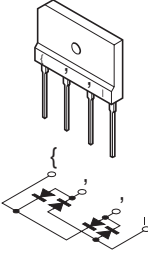
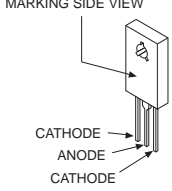
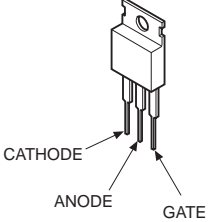
<p>2SB709A-QRS-TX 2SD601A-QRS-TX</p> 	<p>2SB734-T-34 2SC3209LK-TP</p> 	<p>2SA1309A-QRSTA 2SC3311A-QRSTA 2SD2144S-TP-UVW</p> 	<p>2SC3840K</p> 	<p>2SA1837</p> 
<p>2SA10910-TPE2</p> 	<p>IRF614</p> 	<p>2SK2663</p> 	<p>2SC4793</p> 	<p>2SD2578-YB</p> 
<p>ERA38-06TP1 ERA82-004TP5 1SS133T-77 D1NS0R-TA MTZJ-T-77-12C MTZJ-T-77-15B MTZJ-T-77-33B MTZJ-T-77-39</p> 	<p>RU-1P ERC06-15S EGP20DPKG23 MTZJ-T-77-5.1C MTZJ-T-77-5.6C MTZJ-T-77-7.5A MTZJ-T-77-10B MTZJ-T-77-30D RGP10-GPKG3 RGP02-17PKG23 RGP15GPKG23</p> 	<p>ERB44-06TP1 1SS83TD GP08DPKG23 RGP10GPKG23 RU4AM-T3</p> 	<p>RD9.1EW-T1</p> 	<p>MA111-TX UDZ-TE-17.5.1B UDZ-TE-17.91B</p> 
<p>D2SB60A-F04</p> 	<p>DAP202K-T-146</p> 	<p>D4SB60L-F</p> 		
<p>D5LC20U</p> 	<p>TF541M</p> 			

SECTION 6: EXPLODED VIEWS

Components not identified by a part number or description are not stocked because they are seldom required for routine service.

The component parts of an assembly are indicated by the reference numbers in the far right column of the parts list and within the dotted lines of the diagram.

* Items marked with an asterisk are not stocked since they are seldom required for routine service. Expect some delay when ordering these components.

NOTE: The components identified by shading and mark are critical for safety. Replace only with part number specified.

NOTE: Les composants identifiés par un trame et une marque sont critiques pour la sécurité. Ne les remplacer que par une pièce portant le numéro spécifié.

6-1. PICTURE TUBE (KV-27FS120/29FS120 ONLY)

- 4-388-477-01 SCREW(3X16), TAPPING, +BV WASHER
- ▲ 4-046-765-12 SCREW, TAPPING 7+CROWN WASHER

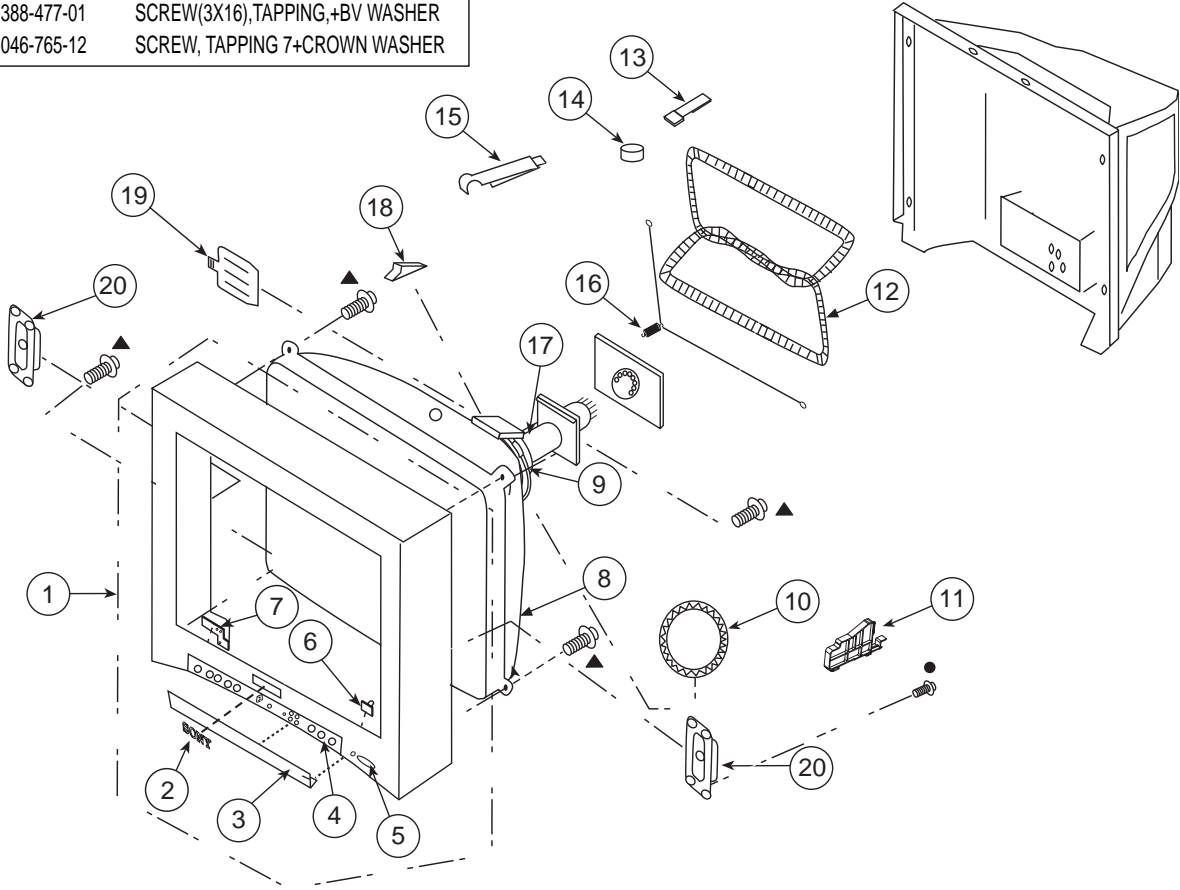

REF. NO.	PART NO.	DESCRIPTION	[ASSEMBLY INCLUDES]	REF. NO.	PART NO.	DESCRIPTION	[ASSEMBLY INCLUDES]
1	X-4043-163-1	BEZNET, ASSY	[2-7]	11	4-089-062-02	SUPPORTER, CRT	
2	4-046-160-31	EMBLEM, SONY NO.9		12	1-419-156-21	COIL, DEGAUSSING (ALL EXCEPT KV-29FS120 L. SOUTH)	
3	4-089-056-11	DOOR		12	1-419-523-21	COIL, DEGAUSSING (KV-29FS120 L. SOUTH ONLY)	
4	4-089-016-01	LABEL, DOOR		13	4-083-414-01	PIECE A(110), CONV CORRECT	
5	4-089-057-11	BUTTON, POWER		14	1-452-885-11	MAGNET, LANDING	
6	4-089-058-01	GUIDE, LED		* 15	4-062-970-12	CLIP (29RSN), DGC	
* 7	4-083-303-01	SPRING, METAL		16	4-036-329-01	SPRING (B), TENSION	
8	8-735-082-05	CRT 29RSN(SDP) (ALL EXCEPT KV-29FS120 L. SOUTH)		17	8-453-011-11	NECK ASSEMBLY 299-M	
8	8-735-083-05	CRT 29RSN(SDP)(SOUTH) (KV-29FS120 L. SOUTH ONLY)		18	4-053-005-01	SPACER, DY	
9	8-451-494-41	DY Y29RSA-V		19	4-081-170-01	PLATE, TLH CORRECTION	
10	1-452-896-11	COIL, NA ROTATION (RT-200)		20	1-825-206-11	LOUDSPEAKER (6X12CM)	







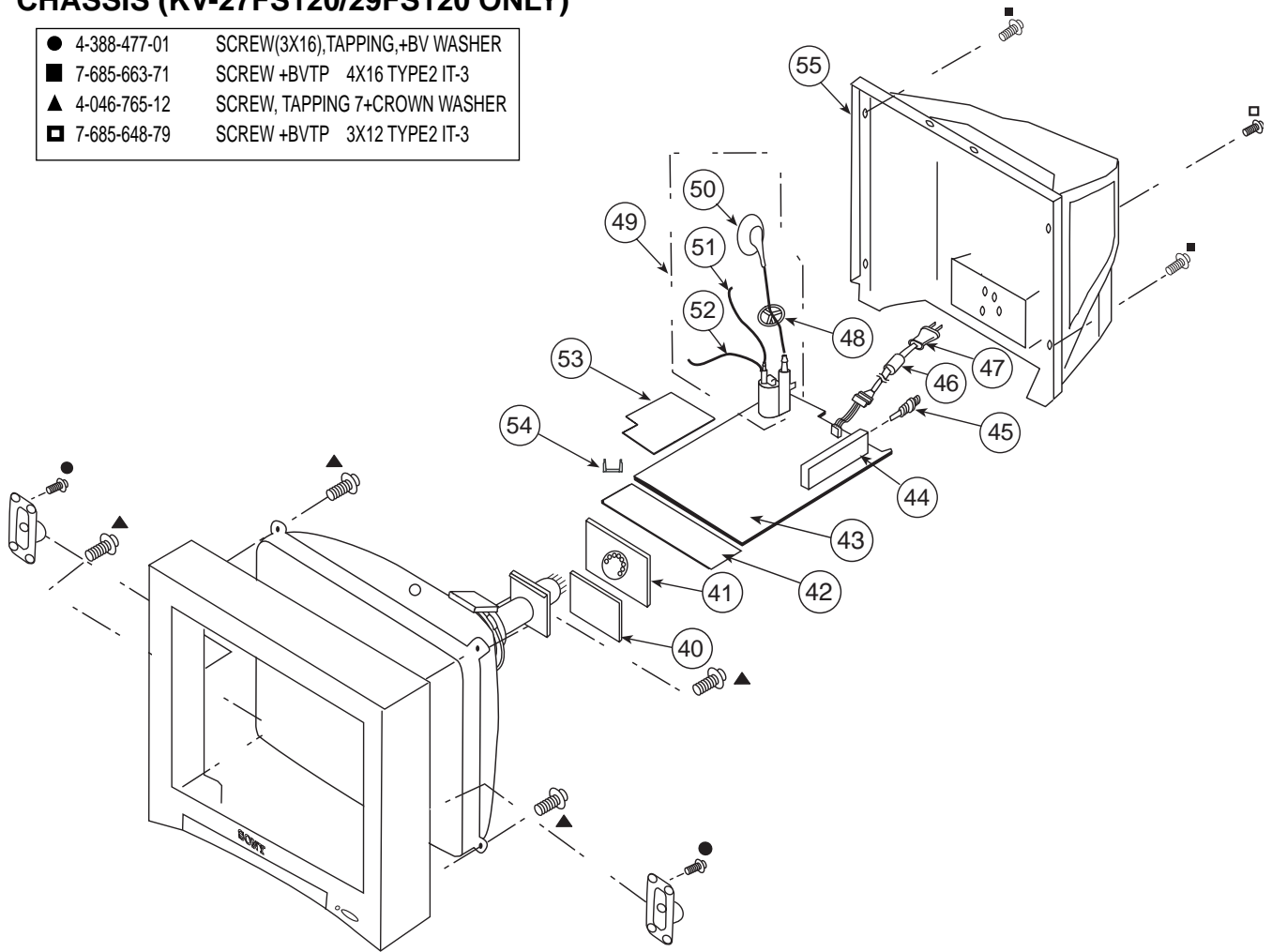

NOTE: The components identified by shading and  mark are critical for safety. Replace only with part number specified.

NOTE: Les composants identifiés par un trame et une marque  sont critiques pour la sécurité. Ne les remplacer que par une pièce portant le numéro spécifié.

6-2. CHASSIS (KV-27FS120/29FS120 ONLY)

- 4-388-477-01 SCREW(3X16),TAPPING,+BV WASHER
- 7-685-663-71 SCREW +BVTP 4X16 TYPE2 IT-3
- ▲ 4-046-765-12 SCREW, TAPPING 7+CROWN WASHER
- ▣ 7-685-648-79 SCREW +BVTP 3X12 TYPE2 IT-3



REF. NO.	PART NO.	DESCRIPTION	[ASSEMBLY INCLUDES]	REF. NO.	PART NO.	DESCRIPTION	[ASSEMBLY INCLUDES]
* 40	A-1410-924-A	V BOARD, MOUNTED			1-824-069-11	CORD, AC POWER (WITH CONNECTOR)	
* 41	A-1410-925-A	CW BOARD, MOUNTED			1-757-840-12	CORD, POWER (WITH CONNECTOR)	
* 42	A-1415-674-A	HS BOARD, MOUNTED				(KV-29FS120 L. SOUTH ONLY)	
* 43	A-1052-931-A	A BOARD, COMPLETE		48	4-084-918-01	HOLDER, HV CABLE	
		(KV-29FS120 L. SOUTH ONLY)			1-453-310-21	FBT ASSY NX-4521//X4J4	[50-52]
		The high-voltage leads associated with the FBT on the A board are not included and must be ordered separately. (See 50-52)			1-251-374-14	CAP ASSY, HIGH-VOLTAGE	
* 43	A-1302-967-A	A BOARD, COMPLETE			1-900-800-65	CONNECTOR ASSY, FOCUS LEAD	
		(ALL EXCEPT KV-29FS120 L. SOUTH)			1-900-803-22	WIRE ASSY, G2 LEAD	
		The high-voltage leads associated with the FBT on the A board are not included and must be ordered separately. (See 50-52)		* 53	A-1415-635-A	D BOARD, MOUNTED	
	44	8-598-593-50	TUNER, FSS BTF-WA421	* 54	3-696-606-02	HINGE, VI	
	45	1-766-374-11	PLUG, F-PIN	55	4-089-050-32	COVER, REAR	
	46	1-500-586-11	FILTER, CLAMP (FERRITE CORE)				
		(KV-29FS120 L. SOUTH ONLY)					







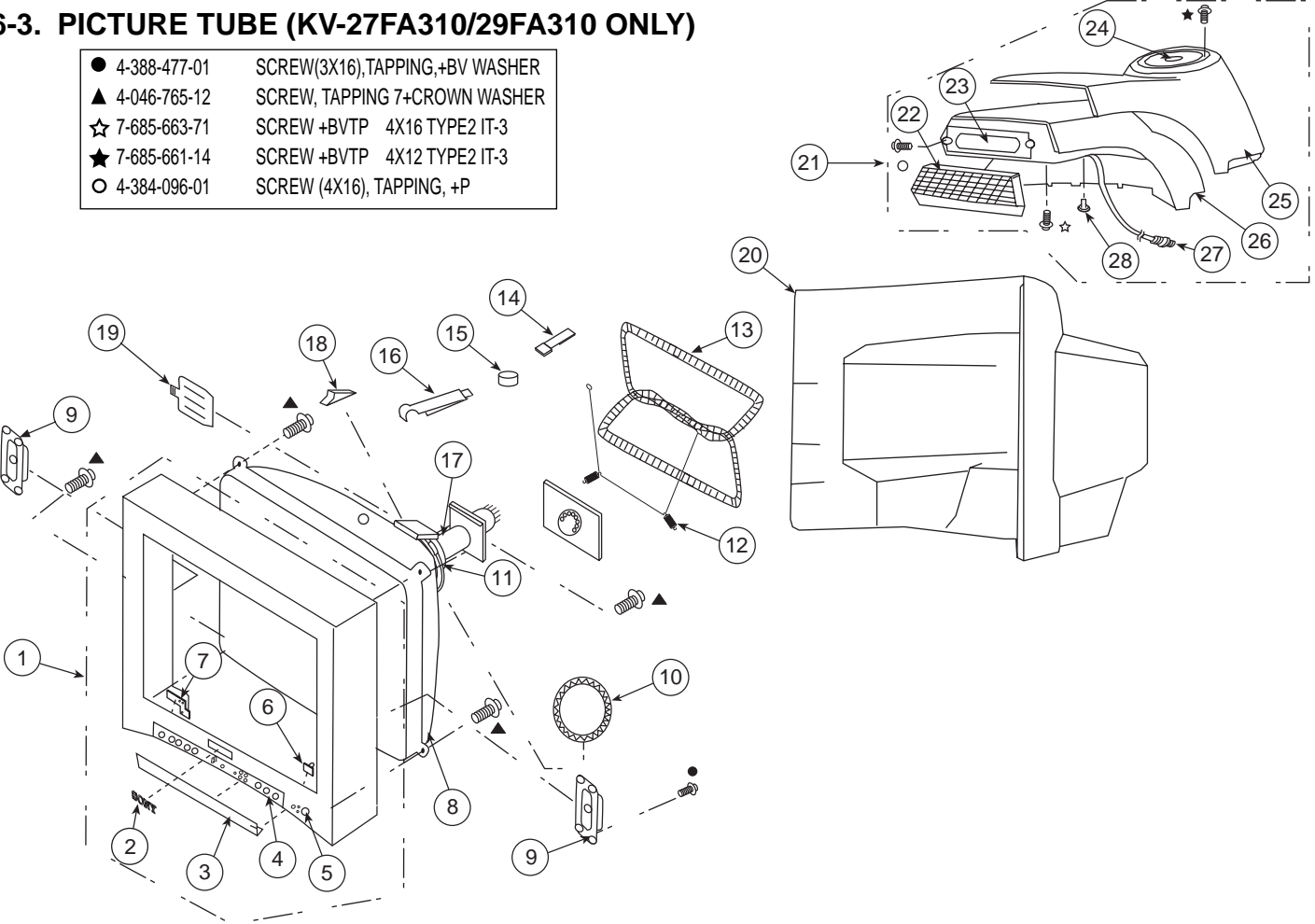

NOTE: The components identified by shading and  mark are critical for safety. Replace only with part number specified.

NOTE: Les composants identifiés par un trame et une marque  sont critiques pour la securite. Ne les remplacer que par une piece portant le numero specifie.

6-3. PICTURE TUBE (KV-27FA310/29FA310 ONLY)

- 4-388-477-01 SCREW(3X16),TAPPING,+BV WASHER
- ▲ 4-046-765-12 SCREW, TAPPING 7+CROWN WASHER
- ☆ 7-685-663-71 SCREW +BVTP 4X16 TYPE2 IT-3
- ★ 7-685-661-14 SCREW +BVTP 4X12 TYPE2 IT-3
- 4-384-096-01 SCREW (4X16), TAPPING, +P



REF. NO.	PART NO.	DESCRIPTION	[ASSEMBLY INCLUDES]	REF. NO.	PART NO.	DESCRIPTION	[ASSEMBLY INCLUDES]
1	X-4043-169-2	BEZNET ASSY (KV-27FA310 ONLY)	[2-7]		13	1-419-523-21	COIL, DEGAUSSING (KV-29FA310 L. SOUTH ONLY)
1	X-4043-169-1	BEZNET ASSY (KV-29FA310 ONLY)	[2-7]	14	4-083-414-01	PIECE A(110), CONV CORRECT	
2	4-046-160-31	EMBLEM, SONY NO.9		15	1-452-885-11	MAGNET, LANDING	
* 3	4-087-375-31	DOOR, CONTROL		* 16	4-062-970-12	CLIP (29RSN), DGC	
4	4-087-376-21	LABEL, FRONT TERMINAL			17	8-453-011-11	NECK ASSEMBLY 299-M
5	4-087-150-41	BUTTON, POWER		18	4-053-005-01	SPACER, DY	
6	4-087-156-01	GUIDE, LIGHT		19	4-081-170-01	PLATE, TLH CORRECTION	
7	4-087-374-11	SPRING, DOOR		20	4-093-996-12	COVER, REAR (KV-27FA310 ONLY)	
	8	8-735-082-05	CRT 29RSN(SDP) M68LNH050X (KV-27FA310 & KV-29FA310 L. NORTH ONLY)	20	4-093-996-11	COVER, REAR (KV-29FA310 ONLY)	
	8	8-735-083-05	CRT 29RSN(SDP)(SOUTH) (KV-29FA310 L. SOUTH ONLY)	21	A-1606-603-A	SPEAKER ASSY (29)	[22-28]
9	1-825-417-21	LOUDSPEAKER (16X12CM)		* 22	4-101-820-01	GRILLE, CENTER (W29)	
	10	1-452-896-11	COIL, NA ROTATION (RT-200)	23	1-825-809-11	LOUDSPEAKER (19.2CMX4.2CM)	
	11	8-451-494-41	DY Y29RSA-V	24	1-825-807-11	LOUDSPEAKER (13CM)	
12	4-036-329-01	SPRING (B), TENSION		* 25	X-2022-510-1	TOP ASSY (W29), COVER	
	13	1-419-156-22	COIL, DEGAUSSING (KV-27FA310 ONLY)	* 26	4-101-830-01	COVER, BOTTOM (W29)	
	13	1-419-156-21	COIL, DEGAUSSING (KV-29FA310 L. NORTH ONLY)	* 27	1-828-903-11	CONNECTION CABLE	
				* 28	4-068-528-41	FOOT	







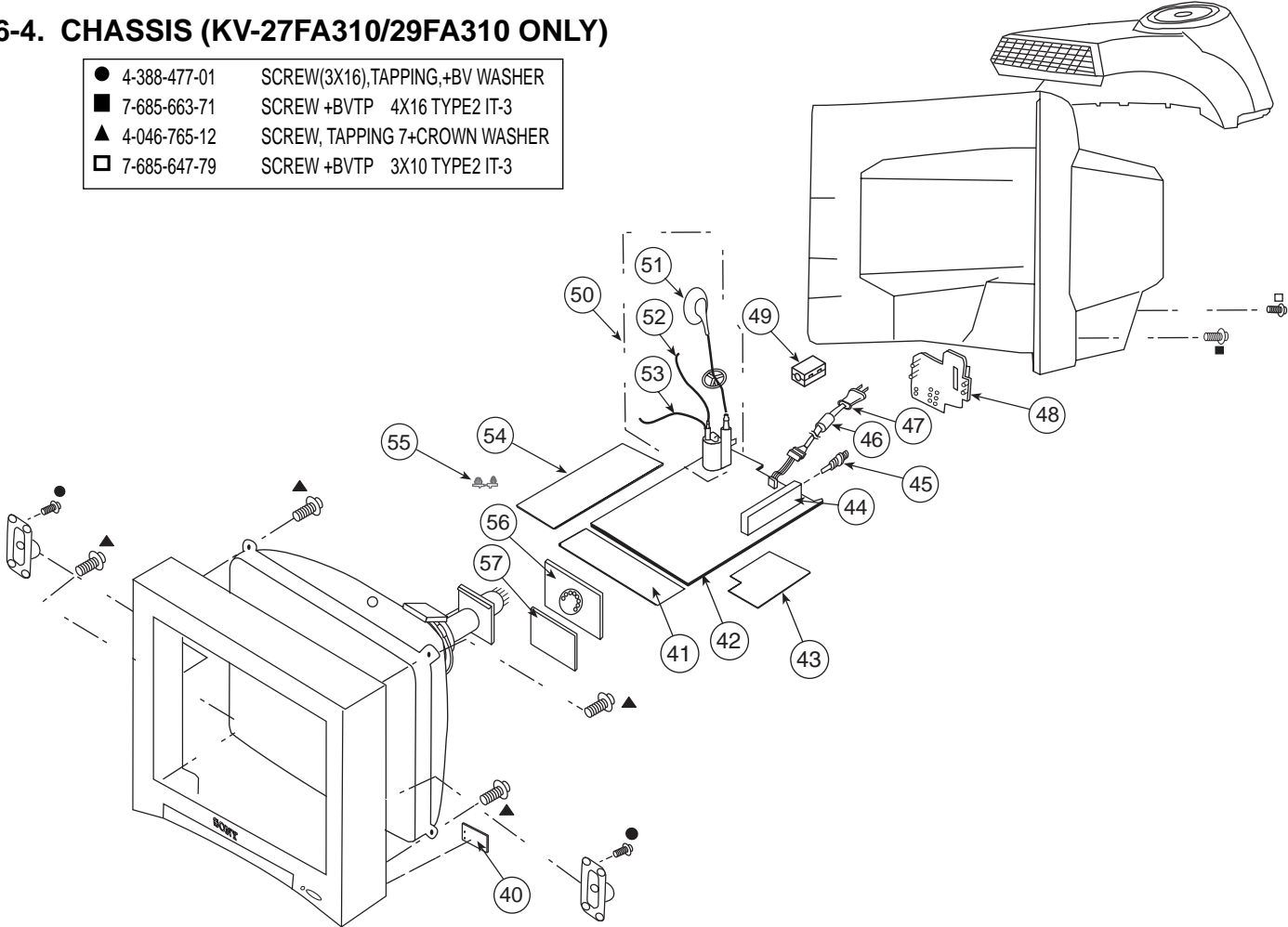

NOTE: The components identified by shading and  mark are critical for safety. Replace only with part number specified.

NOTE: Les composants identifiés par un trame et une marque  sont critiques pour la sécurité. Ne les remplacer que par une pièce portant le numéro spécifié.

6-4. CHASSIS (KV-27FA310/29FA310 ONLY)

- 4-388-477-01 SCREW(3X16),TAPPING,+BV WASHER
- 7-685-663-71 SCREW +BVTP 4X16 TYPE2 IT-3
- ▲ 4-046-765-12 SCREW, TAPPING 7+CROWN WASHER
- 7-685-647-79 SCREW +BVTP 3X10 TYPE2 IT-3



REF. NO.	PART NO.	DESCRIPTION	[ASSEMBLY INCLUDES]	REF. NO.	PART NO.	DESCRIPTION	[ASSEMBLY INCLUDES]
* 40	A-1415-629-A	HR (VAR) BOARD, MOUNTED		 47	1-757-840-12	CORD, POWER (WITH CONNECTOR) (KV-29FA310 L. SOUTH ONLY)	
* 41	A-1415-631-A	HU (VAR) BOARD, MOUNTED		* 48	4-087-877-41	TERMINAL BRACKET	
* 42	A-1302-880-A	A BOARD, COMPLETE (KV-27FA310 & KV-29FA310 L. NORTH ONLY)		49	1-500-082-11	CLAMP, SLEEVE FERRITE	
		The high-voltage leads associated with the FBT on the A board are not included and must be ordered separately. (See 51-53)		 50	1-453-310-21	FBT ASSY NX-4521//X4J4	[51-53]
* 42	A-1302-954-A	A BOARD, COMPLETE (KV-29FA310 L. SOUTH ONLY)		 51	1-251-374-14	CAP ASSY, HIGH-VOLTAGE	
		The high-voltage leads associated with the FBT on the A board are not included and must be ordered separately. (See 51-53)		 52	1-900-800-65	CONNECTOR ASSY, FOCUS LEAD	
* 43	A-1410-921-A	K BOARD, MOUNTED		 53	1-900-803-22	WIRE ASSY, G2 LEAD	
 44	8-598-593-50	TUNER, FSS BTF-WA421		* 54	A-1410-927-A	GD (COM) BOARD, MOUNTED	
 45	1-766-374-11	PLUG, F-PIN		* 55	4-076-951-01	HINGE, PWB	
46	1-500-586-11	FILTER, CLAMP (FERRITE CORE) (KV-29FA310 L. SOUTH ONLY)		* 56	A-1410-925-A	CW BOARD, MOUNTED	
 47	1-824-069-11	CORD, AC POWER (WITH CONNECTOR) (KV-27FA310 & KV-29FA310 L. NORTH ONLY)		* 57	A-1410-924-A	V BOARD, MOUNTED	

NOTE: The components identified by shading and \triangle mark are critical for safety. Replace only with part number specified.

NOTE: Les composants identifiés par un triangle et une marque \triangle sont critiques pour la sécurité. Ne les remplacer que par une pièce portant le numéro spécifié.







REF. NO.	PART NO.	DESCRIPTION	VALUES			REF. NO.	PART NO.	DESCRIPTION	VALUES		
C204	1-216-864-11	SHORT CHIP				C419	1-125-891-11	CERAMIC CHIP	0.47 μ F	10%	10V
C205	1-216-864-11	SHORT CHIP				C420	1-126-960-11	ELECT	1 μ F	20%	50V
C206	1-126-963-11	ELECT	4.7 μ F	20%	50V	C421	1-126-965-91	ELECT	22 μ F	20%	50V
C207	1-126-963-11	ELECT	4.7 μ F	20%	50V	C422	1-126-960-11	ELECT	1 μ F	20%	50V
C212	1-126-963-11	ELECT	4.7 μ F	20%	50V	C423	1-126-963-11	ELECT	4.7 μ F	20%	50V
C213	1-126-963-11	ELECT	4.7 μ F	20%	50V	C424	1-125-891-11	CERAMIC CHIP	0.47 μ F	10%	10V
C220	1-125-891-11	CERAMIC CHIP	0.47 μ F	10%	10V	C430	1-126-963-11	ELECT	4.7 μ F	20%	50V
C301	1-126-956-91	ELECT	0.1 μ F	20%	50V	C431	1-126-963-11	ELECT	4.7 μ F	20%	50V
C302	1-126-956-91	ELECT	0.1 μ F	20%	50V	C436	1-107-826-11	CERAMIC CHIP	0.1 μ F	10%	16V
C303	1-126-956-91	ELECT	0.1 μ F	20%	50V	C450	1-126-943-11	ELECT	2200 μ F	20%	25V
C304	1-126-956-91	ELECT	0.1 μ F	20%	50V	C451	1-126-959-11	ELECT	0.47 μ F	20%	50V
C305	1-107-826-11	CERAMIC CHIP	0.1 μ F	10%	16V	C452	1-126-960-11	ELECT	1 μ F	20%	50V
C306	1-107-826-11	CERAMIC CHIP	0.1 μ F	10%	16V	C457	1-127-715-91	CERAMIC CHIP	0.22 μ F	10%	16V
C307	1-107-826-11	CERAMIC CHIP	0.1 μ F	10%	16V			(KV-27FS120/29FS120LN/29FS120LS ONLY)			
C313	1-126-956-91	ELECT	0.1 μ F	20%	50V	C457	1-165-176-11	CERAMIC CHIP	0.047 μ F	10%	16V
C317	1-126-964-11	ELECT	10 μ F	20%	50V			(KV-27FA310/29FA310 ONLY)			
C318	1-126-964-11	ELECT	10 μ F	20%	50V	C458	1-127-715-91	CERAMIC CHIP	0.22 μ F	10%	16V
C319	1-126-964-11	ELECT	10 μ F	20%	50V			(KV-27FS120/29FS120LN/29FS120LS ONLY)			
C325	1-162-967-11	CERAMIC CHIP	0.0033 μ F	10%	50V	C458	1-165-176-11	CERAMIC CHIP	0.047 μ F	10%	16V
C326	1-164-505-11	CERAMIC CHIP	2.2 μ F		16V			(KV-27FA310/29FA310 ONLY)			
C328	1-162-970-11	CERAMIC CHIP	0.01 μ F	10%	25V	C460	1-126-943-11	ELECT	2200 μ F	20%	25V
C330	1-162-970-11	CERAMIC CHIP	0.01 μ F	10%	25V	C461	1-126-943-11	ELECT	2200 μ F	20%	25V
C337	1-162-919-11	CERAMIC CHIP	22pF	5%	50V	C462	1-126-943-11	ELECT	2200 μ F	20%	25V
C351	1-164-315-11	CERAMIC CHIP	470pF	5%	50V	C463	1-126-943-11	ELECT	2200 μ F	20%	25V
C370	1-162-968-11	CERAMIC CHIP	0.0047 μ F	10%	50V	C470	1-126-935-11	ELECT	470 μ F	20%	16V
C390	1-162-970-11	CERAMIC CHIP	0.01 μ F	10%	25V	C501	1-126-959-11	ELECT	0.47 μ F	20%	50V
C400	1-128-934-91	CERAMIC CHIP	0.33 μ F	20%	10V	C502	1-102-112-00	CERAMIC	330pF	10%	50V
C401	1-164-227-11	CERAMIC CHIP	0.022 μ F	10%	25V	C503	1-106-383-00	MYLAR	0.047 μ F	10%	200V
C402	1-164-174-11	CERAMIC CHIP	0.0082 μ F	10%	25V	C504	1-102-228-00	CERAMIC	470pF	10%	500V
C403	1-162-967-11	CERAMIC CHIP	0.0033 μ F	10%	50V	C505	1-102-228-00	CERAMIC	470pF	10%	500V
C404	1-162-967-11	CERAMIC CHIP	0.0033 μ F	10%	50V	\triangle C506	1-117-214-11	CERAMIC	0.001 μ F	10%	2KV
C405	1-164-677-11	CERAMIC CHIP	0.033 μ F	10%	16V	\triangle C507	1-127-717-21	FILM	19000pF	3%	1.2KV
C406	1-164-677-11	CERAMIC CHIP	0.033 μ F	10%	16V	\triangle C508	1-129-722-00	FILM	0.047 μ F	5%	630V
C407	1-162-965-11	CERAMIC CHIP	0.0015 μ F	10%	50V	C509	1-126-964-11	ELECT	10 μ F	20%	50V
C408	1-162-965-11	CERAMIC CHIP	0.0015 μ F	10%	50V	\triangle C510	1-162-116-00	CERAMIC	680pF	10%	2KV
C409	1-127-715-91	CERAMIC CHIP	0.22 μ F	10%	16V	C511	1-109-844-11	FILM	0.68 μ F	5%	400V
C410	1-127-715-91	CERAMIC CHIP	0.22 μ F	10%	16V	C512	1-104-987-11	MYLAR	0.001 μ F	5%	200V
C411	1-128-934-91	CERAMIC CHIP	0.33 μ F	20%	10V	\triangle C513	1-106-383-00	MYLAR	0.047 μ F	10%	200V
C412	1-126-960-11	ELECT	1 μ F	20%	50V	C514	1-115-521-11	FILM	0.82 μ F	5%	250V
C413	1-126-963-11	ELECT	4.7 μ F	20%	50V	C515	1-107-649-11	ELECT	2.2 μ F	20%	250V
C414	1-126-961-11	ELECT	2.2 μ F	20%	50V	C516	1-117-412-11	FILM	0.24 μ F	5%	250V
C415	1-126-963-11	ELECT	4.7 μ F	20%	50V	C519	1-216-864-11	SHORT CHIP			
C416	1-126-960-11	ELECT	1 μ F	20%	50V	C520	1-126-965-91	ELECT	22 μ F	20%	50V
C418	1-126-963-11	ELECT	4.7 μ F	20%	50V	C521	1-126-960-11	ELECT	1 μ F	20%	50V

NOTE: The components identified by shading and  mark are critical for safety. Replace only with part number specified.

NOTE: Les composants identifiés par un trame et une  sont critiques pour la sécurité. Ne les remplacer que par une pièce portant le numéro spécifique.



REF. NO.	PART NO.	DESCRIPTION	VALUES			REF. NO.	PART NO.	DESCRIPTION	VALUES		
C522	1-102-244-00	CERAMIC	220pF	10%	500V	 C602	1-165-529-11	MYLAR	0.22µF	10	275V
C523	1-165-529-11	MYLAR	0.22µF	10	275V	 C603	1-165-529-11	MYLAR	0.22µF	10	275V
C525	1-164-646-11	CERAMIC	2200pF	10%	500V	 C605	1-117-699-11	CERAMIC	0.001µF	20%	250V
C526	1-102-244-00	CERAMIC	220pF	10%	500V	C609	1-126-942-61	ELECT	1000µF	20%	25V
C527	1-107-645-11	ELECT	22µF	20%	200V	C610	1-164-645-11	CERAMIC	1000pF	10%	500V
											(KV-27FS120/29FS120LN/29FS120LS ONLY)
C529	1-164-690-91	CERAMIC CHIP	0.0022µF	5%	50V	C611	1-126-971-11	ELECT	470µF	20%	50V
C534	1-162-966-11	CERAMIC CHIP	0.0022µF	10%	50V	C612	1-126-961-11	ELECT	2.2µF	20%	50V
C536	1-162-968-11	CERAMIC CHIP	0.0047µF	10%	50V	C613	1-161-964-91	CERAMIC	0.0047µF		250V
C537	1-162-964-11	CERAMIC CHIP	0.001µF	10%	50V	C615	1-161-964-91	CERAMIC	0.0047µF		250V
C539	1-162-970-11	CERAMIC CHIP	0.01µF	10%	25V	C616	1-126-943-11	ELECT	2200µF	20%	25V
											(KV-27FS120/29FS120LN/29FS120LS ONLY)
C542	1-162-966-11	CERAMIC CHIP	0.0022µF	10%	50V	C617	1-107-935-11	ELECT	330µF	20%	100V
C543	1-102-106-00	CERAMIC CHIP	.0001µF		50V						(KV-27FS120/29FS120LN/29FS120LS ONLY)
											(KV-27FA310/29FA310 ONLY)
C544	1-126-967-11	ELECT	47µF	20%	50V	C618	1-107-935-11	ELECT	330µF	20%	100V
C545	1-126-969-11	ELECT	220µF	20%	50V						(KV-27FS120/29FS120LN/29FS120LS ONLY)
C546	1-137-194-81	FILM	0.47µF	5%	50V	C620	1-162-970-11	CERAMIC CHIP	0.01µF	10%	25V
C549	1-101-821-00	CERAMIC	0.0022µF		500V						(KV-27FS120/29FS120LN/29FS120LS ONLY)
C550	1-104-666-11	ELECT	220µF	20%	25V	C621	1-117-893-11	ELECT	470µF	20%	250V
C551	1-126-960-11	ELECT	1µF	20%	50V						(KV-27FS120/29FS120LN/29FS120LS ONLY)
C552	1-126-964-11	ELECT	10µF	20%	50V	C621	1-117-894-11	ELECT	560µF	20%	250V
											(KV-27FA310/29FA310 ONLY)
C553	1-107-826-11	CERAMIC CHIP	0.1µF	10%	16V	C624	1-107-636-11	ELECT	10µF	20%	160V
C554	1-162-970-11	CERAMIC CHIP	0.01µF	10%	25V						(KV-27FS120/29FS120LN/29FS120LS ONLY)
C555	1-101-821-00	CERAMIC	0.0022µF		500V	C625	1-126-964-11	ELECT	10µF	20%	50V
C558	1-162-318-11	CERAMIC	0.001µF	10%	500V						(KV-27FS120/29FS120LN/29FS120LS ONLY)
C559	1-216-864-11	SHORT CHIP				C629	1-117-893-11	ELECT	470µF	20%	250V
											(KV-27FS120/29FS120LN/29FS120LS ONLY)
C560	1-216-833-11	METAL CHIP	10K	5%	1/10W	C629	1-117-894-11	ELECT	560µF	20%	250V
C561	1-126-963-11	ELECT	4.7µF	20%	50V						(KV-27FA310/29FA310 ONLY)
C562	1-104-666-11	ELECT	220µF	20%	25V	 C631	1-113-896-11	CERAMIC	220pF	10%	250V
C563	1-162-970-11	CERAMIC CHIP	0.01µF	10%	25V						(KV-27FS120/29FS120LN/29FS120LS ONLY)
C566	1-107-635-11	ELECT	4.7µF	20%	160V	C632	1-126-967-11	ELECT	47µF	20%	50V
											(KV-27FS120/29FS120LN/29FS120LS ONLY)
C571	1-104-665-11	ELECT	100µF	20%	25V	C633	1-136-479-11	FILM	0.001µF	5%	100V
C581	1-136-161-00	FILM	0.047µF	5%	50V						(KV-27FS120/29FS120LN/29FS120LS ONLY)
C582	1-106-387-00	MYLAR	0.068µF	10%	200V	C634	1-126-947-11	ELECT	47µF	20%	35V
C585	1-104-666-11	ELECT	220µF	20%	25V						(KV-27FS120/29FS120LN/29FS120LS ONLY)
C588	1-137-417-11	MYLAR	0.015µF	10%	100V	C635	1-126-963-11	ELECT	4.7µF	20%	50V
											(KV-27FS120/29FS120LN/29FS120LS ONLY)
C589	1-128-560-11	ELECT	22µF	20%	100V	C636	1-127-715-91	CERAMIC CHIP	0.22µF	10%	16V
C590	1-126-964-11	ELECT	10µF	20%	50V						(KV-27FS120/29FS120LN/29FS120LS ONLY)
C594	1-123-024-21	ELECT	33µF		160V	C637	1-127-715-91	CERAMIC CHIP	0.22µF	10%	16V
C595	1-104-666-11	ELECT	220µF	20%	25V						(KV-27FS120/29FS120LN/29FS120LS ONLY)
C597	1-104-666-11	ELECT	220µF	20%	25V	C638	1-104-665-11	ELECT	100µF	20%	25V
											(KV-29FS120LS/29FA310LS ONLY)
C600	1-126-964-11	ELECT	10µF	20%	50V						
C601	1-117-703-11	CERAMIC	0.0047µF		250V						

NOTE: The components identified by shading and \triangle mark are critical for safety. Replace only with part number specified.

NOTE: Les composants identifiés par un trame et une marque \triangle sont critiques pour la sécurité. Ne les remplacer que par une pièce portant le numéro spécifié.



REF. NO.	PART NO.	DESCRIPTION	VALUES	REF. NO.	PART NO.	DESCRIPTION	VALUES
C640	1-164-645-11	CERAMIC (KV-27FS120/29FS120LN/29FS120LS ONLY)	1000pF 10% 50V	*	CN515	1-580-798-11	CONNECTOR PIN (DY) 6P
C642	1-126-969-11	ELECT (KV-27FS120/29FS120LN/29FS120LS ONLY)	220 μ F 20% 50V	*	CN585	1-564-511-11	PLUG, CONNECTOR 8P
C643	1-130-777-00	MYLAR (KV-27FS120/29FS120LN/29FS120LS ONLY)	0.1 μ F 5% 100V	\triangle	CN600	1-580-843-11	PIN, CONNECTOR (POWER)
C645	1-162-964-11	CERAMIC CHIP (KV-27FS120/29FS120LN/29FS120LS ONLY)	0.001 μ F 10% 50V	*	CN601	1-580-843-11	PIN, CONNECTOR (POWER) (KV-27FA310/29FA310 ONLY)
C647	1-126-947-11	ELECT (KV-27FS120/29FS120LN/29FS120LS ONLY)	47 μ F 20% 35V	*	CN602	1-564-509-11	PLUG, CONNECTOR 6P (KV-27FA310/29FA310 ONLY)
C648	1-104-330-91	CERAMIC (KV-27FS120/29FS120LN/29FS120LS ONLY)	470pF 10% 1KV	DIODE			
C650	1-126-942-61	ELECT (KV-27FS120/29FS120LN/29FS120LS ONLY)	1000 μ F 20% 25V	D002	8-719-109-89	DIODE	RD5.6ESB2
C651	1-126-942-61	ELECT (KV-27FS120/29FS120LN/29FS120LS ONLY)	1000 μ F 20% 25V	D003	8-719-110-17	DIODE	RD10ESB2
C652	1-164-227-11	CERAMIC CHIP (KV-27FS120/29FS120LN/29FS120LS ONLY)	0.022 μ F 10% 25V	D004	8-719-110-17	DIODE	RD10ESB2
C655	1-104-330-91	CERAMIC (KV-27FS120/29FS120LN/29FS120LS ONLY)	470pF 10% 1KV	D005	8-719-110-17	DIODE	RD10ESB2
C660	1-126-947-11	ELECT	47 μ F 20% 35V	D006	8-719-921-44	DIODE	MTZJ-5.1C
C661	1-104-665-11	ELECT	100 μ F 20% 25V	D007	8-719-982-22	DIODE	MTZJ-30D
C665	1-104-665-11	ELECT	100 μ F 20% 25V	D046	8-719-109-89	DIODE	RD5.6ESB2
C672	1-137-756-22	FILM (KV-27FS120/29FS120LN/29FS120LS ONLY)	22000pF 3% 800V	D047	8-719-109-89	DIODE	RD5.6ESB2
C673	1-126-963-11	ELECT	4.7 μ F 20% 50V	D050	8-719-510-02	DIODE	D1NS4
\triangle C680	1-117-699-11	CERAMIC	0.001 μ F 20% 250V	D051	6-500-175-01	DIODE	1E3-TB
C690	1-162-970-11	CERAMIC CHIP	0.01 μ F 10% 25V	D052	8-719-109-89	DIODE	RD5.6ESB2
C901	1-218-712-11	METAL CHIP	6.8K 0.50% 1/10W	D200	8-719-929-15	DIODE	HZS9.1NB2
CONNECTOR				D201	8-719-929-15	DIODE	HZS9.1NB2
*	CN002	1-564-510-11 (KV-27FS120/29FS120LN/29FS120LS ONLY)	PLUG, CONNECTOR 7P	D202	8-719-929-15	DIODE	HZS9.1NB2
*	CN002	1-564-509-11 (KV-27FA310/29FA310 ONLY)	PLUG, CONNECTOR 6P	D203	8-719-929-15	DIODE	HZS9.1NB2
*	CN003	1-560-124-00	PLUG, CONNECTOR (2.5MM) 4P	D204	8-719-929-15	DIODE	HZS9.1NB2
*	CN004	1-564-510-11	PLUG, CONNECTOR 7P	D205	8-719-929-15	DIODE	HZS9.1NB2
*	CN401	1-564-507-11	PLUG, CONNECTOR 4P	D206	8-719-070-62	DIODE	PDZ9.1B-115
*	CN404	1-564-507-11 (KV-27FA310/29FA310 ONLY)	PLUG, CONNECTOR 4P	D207	8-719-404-50	DIODE	MA111-TX
*	CN501	1-573-963-11	PIN, CONNECTOR (PC BOARD) 3P	D208	8-719-929-15	DIODE	HZS9.1NB2
*	CN506	1-564-507-11 (KV-27FS120/29FS120LN/29FS120LS ONLY)	PLUG, CONNECTOR 4P	D209	8-719-404-50	DIODE	MA111-TX
				D230	8-719-108-12	DIODE	RD9.1EW
				D231	8-719-108-12	DIODE	RD9.1EW
				D232	8-719-108-12	DIODE	RD9.1EW
				D233	8-719-108-12	DIODE	RD9.1EW
				D234	8-719-108-12	DIODE	RD9.1EW
				D235	8-719-108-12	DIODE	RD9.1EW
				D236	8-719-108-12	DIODE	RD9.1EW
				D237	8-719-108-12	DIODE	RD9.1EW
				D317	8-719-108-12	DIODE	RD9.1EW
				D321	8-719-110-17	DIODE	RD10ESB2
				D351	8-719-109-66	DIODE	RD3.3ESB2
				D390	8-719-404-50	DIODE	MA111-TX
				D401	8-719-921-63	DIODE	MTZJ-7.5B
				D405	8-719-991-33	DIODE	1SS133T-77



REF. NO.	PART NO.	DESCRIPTION	VALUES	REF. NO.	PART NO.	DESCRIPTION	VALUES
FB617	1-469-578-11	FERRITE (KV-27FS120/29FS120LN/29FS120LS ONLY)	1.1μH	CHIP CONDUCTOR			
		FILTER		JR2	1-216-864-11	SHORT CHIP	
FL001	1-239-803-11	ENCAPSULATED COMPONENT		JR6	1-216-864-11	SHORT CHIP	
		IC		JR7	1-216-864-11	SHORT CHIP	
IC001	6-804-178-01	IC	M65582AUF-XXXFP	JR12	1-216-864-11	SHORT CHIP	
IC002	6-704-004-01	IC	BR24L16F-WE2	JR44	1-216-864-11	SHORT CHIP	
IC003	8-759-352-91	IC	PST9143NL	JR102	1-216-864-11	SHORT CHIP	
IC321	8-759-353-00	IC	NJM2534M(TE2)	JR128	1-216-864-11	SHORT CHIP	
IC400	6-703-190-01	IC (KV-27FS120/29FS120LN/29FS120LS ONLY)	NJW1134AGK1-TE2	JR201	1-216-864-11	SHORT CHIP	
IC400	6-706-033-01	IC (KV-27FA310/29FA310 ONLY)	W1172JK1-TE	JR207	1-216-864-11	SHORT CHIP	
IC404	6-705-054-01	IC	TDA8947J	JR209	1-216-864-11	SHORT CHIP	
IC545	8-759-696-71	IC	STV9379A	JR211	1-216-864-11	SHORT CHIP	
IC561	8-759-700-07	IC	NJM2903M	JR212	1-216-864-11	SHORT CHIP	
IC565	8-759-700-44	IC	NJM2902M	JR213	1-216-864-11	SHORT CHIP	
IC600	6-705-810-01	IC (KV-27FS120/29FS120LN/29FS120LS ONLY)	MCZ3001DB	JR214	1-216-864-11	SHORT CHIP	
IC603	6-705-818-01	IC (KV-27FS120/29FS120LN/29FS120LS ONLY)	MC7809CF	JR215	1-216-864-11	SHORT CHIP	
IC603	6-705-466-01	IC (KV-27FA310/29FA310 ONLY)	BA90BC0T	JR216	1-216-864-11	SHORT CHIP (KV-27FS120/29FS120LN/29FS120LS ONLY)	
IC604	8-749-012-13	IC (KV-27FS120/29FS120LN/29FS120LS ONLY)	DM-58	JR255	1-216-864-11	SHORT CHIP	
IC608	8-759-450-47	IC	BA05T	JR301	1-216-864-11	SHORT CHIP	
IC633	6-703-080-01	IC	LF33CV	JR302	1-216-864-11	SHORT CHIP	
		JACK		JR303	1-216-864-11	SHORT CHIP	
J200	1-794-119-11	TERMINAL BLOCK, S	4P	JR304	1-216-864-11	SHORT CHIP	
J202	1-794-118-11	JACK BLOCK, PIN	3P	JR305	1-216-864-11	SHORT CHIP	
* J203	1-817-461-11	PIN JACK BLOCK	5P	JR306	1-216-864-11	SHORT CHIP	
J205	1-794-116-11	JACK BLOCK, PIN (KV-27FS120/29FS120LN/29FS120LS ONLY)	2P	JR310	1-216-864-11	SHORT CHIP	
J205	1-818-352-11	PIN JACK W/ DIN CONNECTOR (KV-27FA310/29FA310 ONLY)		JR311	1-216-864-11	SHORT CHIP	
				JR312	1-216-864-11	SHORT CHIP	
				JR315	1-216-864-11	SHORT CHIP	
				JR317	1-216-864-11	SHORT CHIP	
				JR401	1-216-864-11	SHORT CHIP	
				JR411	1-216-864-11	SHORT CHIP	
				JR485	1-216-864-11	SHORT CHIP	
				JR486	1-216-864-11	SHORT CHIP	
				JR504	1-216-864-11	SHORT CHIP	
				JR585	1-216-864-11	SHORT CHIP	
				JR586	1-216-864-11	SHORT CHIP	
				JR1502	1-216-864-11	SHORT CHIP	
				JUMPER WIRE			
				JW57	1-249-409-11	CARBON	220 5% 1/4W



REF. NO.	PART NO.	DESCRIPTION	VALUES			REF. NO.	PART NO.	DESCRIPTION	VALUES		
R007	1-400-427-21	FERRITE	0μH			R085	1-216-864-11	SHORT CHIP			
R015	1-216-833-11	METAL CHIP	10K	5%	1/10W	R086	1-216-821-11	METAL CHIP	1K	5%	1/10W
R027	1-218-732-11	METAL CHIP	47K	0.50%	1/10W	R087	1-247-807-31	CARBON	100	5%	1/4W
R028	1-249-409-11	CARBON	220	5%	1/4W	R088	1-216-864-11	SHORT CHIP			
R029	1-249-409-11	CARBON	220	5%	1/4W	R090	1-216-837-11	METAL CHIP	22K	5%	1/10W
R030	1-249-409-11	CARBON	220	5%	1/4W	R091	1-216-841-11	METAL CHIP	47K	5%	1/10W
R031	1-216-813-11	METAL CHIP	220	5%	1/10W	R092	1-216-825-11	METAL CHIP	2.2K	5%	1/10W
R032	1-216-813-11	METAL CHIP	220	5%	1/10W	R093	1-216-841-11	METAL CHIP	47K	5%	1/10W
R033	1-249-409-11	CARBON	220	5%	1/4W	R094	1-414-229-11	FERRITE	0μH		
R035	1-216-809-11	METAL CHIP	100	5%	1/10W	R095	1-216-813-11	METAL CHIP	220	5%	1/10W
R037	1-216-833-11	METAL CHIP	10K	5%	1/10W	R096	1-216-829-11	METAL CHIP	4.7K	5%	1/10W
R038	1-216-821-11	METAL CHIP	1K	5%	1/10W	R098	1-216-839-11	METAL CHIP	33K	5%	1/10W
R039	1-216-815-11	METAL CHIP	330	5%	1/10W	R101	1-216-829-11	METAL CHIP	4.7K	5%	1/10W
R040	1-216-829-11	METAL CHIP	4.7K	5%	1/10W	R102	1-216-837-11	METAL CHIP	22K	5%	1/10W
R041	1-216-829-11	METAL CHIP	4.7K	5%	1/10W	R103	1-216-833-11	METAL CHIP	10K	5%	1/10W
R042	1-216-813-11	METAL CHIP	220	5%	1/10W	R105	1-216-864-11	SHORT CHIP			
R043	1-216-813-11	METAL CHIP	220	5%	1/10W	R107	1-414-229-11	FERRITE	0μH		
R044	1-216-829-11	METAL CHIP	4.7K	5%	1/10W	R108	1-414-229-11	FERRITE	0μH		
R045	1-216-829-11	METAL CHIP	4.7K	5%	1/10W	R109	1-216-829-11	METAL CHIP	4.7K	5%	1/10W
R047	1-249-409-11	CARBON	220	5%	1/4W	R110	1-249-409-11	CARBON	220	5%	1/4W
R048	1-216-829-11	METAL CHIP	4.7K	5%	1/10W	R111	1-216-829-11	METAL CHIP	4.7K	5%	1/10W
R049	1-216-829-11	METAL CHIP	4.7K	5%	1/10W	R112	1-249-425-11	CARBON	4.7K	5%	1/4W
R050	1-249-425-11	CARBON	4.7K	5%	1/4W	R115	1-216-817-11	METAL CHIP	470	5%	1/10W
R051	1-249-417-11	CARBON	1K	5%	1/4W	R116	1-216-853-11	METAL CHIP	470K	5%	1/10W
R052	1-216-813-11	METAL CHIP	220	5%	1/10W	R200	1-216-813-11	METAL CHIP	220	5%	1/10W
R053	1-249-433-11	CARBON	22K	5%	1/4W	R202	1-216-845-11	METAL CHIP	100K	5%	1/10W
R054	1-249-433-11	CARBON	22K	5%	1/4W	R203	1-216-845-11	METAL CHIP	100K	5%	1/10W
R055	1-216-829-11	METAL CHIP	4.7K	5%	1/10W	R210	1-216-845-11	METAL CHIP	100K	5%	1/10W
R056	1-216-833-11	METAL CHIP	10K	5%	1/10W	R211	1-249-409-11	CARBON	220	5%	1/4W
R057	1-249-417-11	CARBON	1K	5%	1/4W	R212	1-249-409-11	CARBON	220	5%	1/4W
R058	1-249-429-11	CARBON	10K	5%	1/4W	R213	1-216-845-11	METAL CHIP	100K	5%	1/10W
R059	1-249-417-11	CARBON	1K	5%	1/4W	R215	1-216-853-11	METAL CHIP	470K	5%	1/10W
R060	1-249-409-11	CARBON	220	5%	1/4W	R216	1-216-853-11	METAL CHIP	470K	5%	1/10W
R061	1-249-429-11	CARBON	10K	5%	1/4W	R217	1-249-409-11	CARBON	220	5%	1/4W
R062	1-249-413-11	CARBON	470	5%	1/4W	R218	1-216-813-11	METAL CHIP	220	5%	1/10W
R063	1-216-829-11	METAL CHIP	4.7K	5%	1/10W	R220	1-216-813-11	METAL CHIP	220	5%	1/10W
R070	1-249-409-11	CARBON	220	5%	1/4W	R221	1-249-409-11	CARBON	220	5%	1/4W
R072	1-249-425-11	CARBON	4.7K	5%	1/4W	R222	1-249-409-11	CARBON	220	5%	1/4W
R076	1-247-807-31	CARBON	100	5%	1/4W	R227	1-218-285-11	METAL CHIP	75	5%	1/10W
R080	1-216-833-11	METAL CHIP	10K	5%	1/10W	R229	1-218-285-11	METAL CHIP	75	5%	1/10W
R081	1-216-841-11	METAL CHIP	47K	5%	1/10W	R230	1-218-285-11	METAL CHIP	75	5%	1/10W
R082	1-216-857-11	METAL CHIP	1M	5%	1/10W	R250	1-216-821-11	METAL CHIP	1K	5%	1/10W
R083	1-216-847-11	METAL CHIP	150K	5%	1/10W	R251	1-216-821-11	METAL CHIP	1K	5%	1/10W
R084	1-216-819-11	METAL CHIP	680	5%	1/10W	R303	1-216-863-11	METAL CHIP	3.3M	5%	1/10W









REF. NO.	PART NO.	DESCRIPTION	VALUES			REF. NO.	PART NO.	DESCRIPTION	VALUES		
R305	1-218-285-11	METAL CHIP	75	5%	1/10W	R405	1-216-833-11	METAL CHIP	10K	5%	1/10W
R308	1-216-821-11	METAL CHIP	1K	5%	1/10W	R406	1-216-813-11	METAL CHIP	220	5%	1/10W
R309	1-216-833-11	METAL CHIP	10K	5%	1/10W	R407	1-216-813-11	METAL CHIP	220	5%	1/10W
R310	1-216-821-11	METAL CHIP	1K	5%	1/10W	R408	1-216-864-11	SHORT CHIP			
R311	1-216-813-11	METAL CHIP	220	5%	1/10W	R409	1-216-864-11	SHORT CHIP			
R312	1-218-867-11	METAL CHIP	6.8K	0.50%	1/10W	R410	1-216-833-11	METAL CHIP	10K	5%	1/10W
R313	1-216-864-11	SHORT CHIP				R411	1-216-833-11	METAL CHIP	10K	5%	1/10W
R314	1-216-833-11	METAL CHIP	10K	5%	1/10W	R415	1-216-809-11	METAL CHIP	100	5%	1/10W
R315	1-216-813-11	METAL CHIP	220	5%	1/10W			(KV-27FA310/29FA310 ONLY)			
R316	1-216-825-11	METAL CHIP	2.2K	5%	1/10W	R418	1-216-809-11	METAL CHIP	100	5%	1/10W
R317	1-216-813-11	METAL CHIP	220	5%	1/10W			(KV-27FA310/29FA310 ONLY)			
R318	1-216-825-11	METAL CHIP	2.2K	5%	1/10W	R419	1-216-864-11	SHORT CHIP			
R319	1-216-813-11	METAL CHIP	220	5%	1/10W			(KV-27FS120/29FS120LN/29FS120LS ONLY)			
R320	1-216-825-11	METAL CHIP	2.2K	5%	1/10W	R420	1-216-864-11	SHORT CHIP			
R321	1-247-807-31	CARBON	100	5%	1/4W			(KV-27FS120/29FS120LN/29FS120LS ONLY)			
R322	1-218-684-11	METAL CHIP	470	0.50%	1/10W	R421	1-216-864-11	SHORT CHIP			
R323	1-215-415-00	METAL	560	1%	1/4W	R422	1-216-833-11	METAL CHIP	10K	5%	1/10W
R324	1-216-821-11	METAL CHIP	1K	5%	1/10W	R427	1-216-841-11	METAL CHIP	47K	5%	1/10W
R325	1-216-864-11	SHORT CHIP				R429	1-216-841-11	METAL CHIP	47K	5%	1/10W
R326	1-400-427-21	FERRITE	0μH			R430	1-216-845-11	METAL CHIP	100K	5%	1/10W
R328	1-400-427-21	FERRITE	0μH			R431	1-216-845-11	METAL CHIP	100K	5%	1/10W
R330	1-218-285-11	METAL CHIP	75	5%	1/10W	R433	1-216-809-11	METAL CHIP	100	5%	1/10W
R335	1-216-813-11	METAL CHIP	220	5%	1/10W	R434	1-216-864-11	SHORT CHIP			
R337	1-216-801-11	METAL CHIP	22	5%	1/10W	R442	1-216-809-11	METAL CHIP	100	5%	1/10W
R338	1-216-864-11	SHORT CHIP				R450	1-249-425-11	CARBON	4.7K	5%	1/4W
R339	1-216-813-11	METAL CHIP	220	5%	1/10W	R477	1-216-819-11	METAL CHIP	680	5%	1/10W
R351	1-216-829-11	METAL CHIP	4.7K	5%	1/10W	R478	1-216-833-11	METAL CHIP	10K	5%	1/10W
R352	1-216-853-11	METAL CHIP	470K	5%	1/10W	R479	1-216-821-11	METAL CHIP	1K	5%	1/10W
R363	1-218-285-11	METAL CHIP	75	5%	1/10W	R499	1-216-845-11	METAL CHIP	100K	5%	1/10W
R364	1-218-285-11	METAL CHIP	75	5%	1/10W	R501	1-249-411-11	CARBON	330	5%	1/4W
R370	1-216-825-11	METAL CHIP	2.2K	5%	1/10W	R502	1-249-425-11	CARBON	4.7K	5%	1/4W
R371	1-216-849-11	METAL CHIP	220K	5%	1/10W	R503	1-215-919-11	METAL OXIDE	2.2K	5%	3W
R372	1-216-827-11	METAL CHIP	3.3K	5%	1/10W	R504	1-249-425-11	CARBON	4.7K	5%	1/4W
R382	1-216-863-11	METAL CHIP	3.3M	5%	1/10W	R507	1-216-833-11	METAL CHIP	10K	5%	1/10W
R390	1-216-864-11	SHORT CHIP				R510	1-260-328-11	CARBON	1K	5%	1/2W
R391	1-216-829-11	METAL CHIP	4.7K	5%	1/10W	R513	1-215-908-00	METAL OXIDE	33	5%	3W
R392	1-216-818-11	METAL CHIP	560	5%	1/10W	R514	1-215-910-00	METAL OXIDE	68	5%	3W
R393	1-216-825-11	METAL CHIP	2.2K	5%	1/10W	R515	1-215-882-00	METAL OXIDE	22	5%	2W
R394	1-216-833-11	METAL CHIP	10K	5%	1/10W	R517	1-216-839-11	METAL CHIP	33K	5%	1/10W
R400	1-216-829-11	METAL CHIP	4.7K	5%	1/10W	R520	1-216-833-11	METAL CHIP	10K	5%	1/10W
R401	1-216-809-11	METAL CHIP	100	5%	1/10W	R521	1-216-819-11	METAL CHIP	680	5%	1/10W
R402	1-216-864-11	SHORT CHIP				R522	1-249-411-11	CARBON	330	5%	1/4W
R403	1-216-809-11	METAL CHIP	100	5%	1/10W	R524	1-218-867-11	METAL CHIP	6.8K	0.50%	1/10W
R404	1-216-825-11	METAL CHIP	2.2K	5%	1/10W	R525	1-215-884-11	METAL OXIDE	47	5%	2W

NOTE: The components identified by shading and  mark are critical for safety. Replace only with part number specified.

A component identified by this  symbol indicates that it has been carefully factory-selected to satisfy regulations regarding X-ray radiation. Should replacement be required, replace only with the value originally used.











REF. NO.	PART NO.	DESCRIPTION	VALUES			REF. NO.	PART NO.	DESCRIPTION	VALUES		
R526	1-218-724-11	METAL CHIP	22K	0.50%	1/10W	R583	1-249-377-11	CARBON	0.47	5%	1/4W
R527	1-216-825-11	METAL CHIP	2.2K	5%	1/10W	R584	1-215-451-00	METAL	18K	1%	1/4W
R528	1-216-816-11	METAL CHIP	390	5%	1/10W	R585	1-215-447-00	METAL	12K	1%	1/4W
R529	1-218-720-11	METAL CHIP	15K	0.50%	1/10W	R586	1-218-855-11	METAL CHIP	2.2K	0.50%	1/10W
R530	1-218-865-11	METAL CHIP	5.6K	0.50%	1/10W	R587	1-249-401-11	CARBON	47	5%	1/4W
R533	1-218-712-11	METAL CHIP	6.8K	0.50%	1/10W	R588	1-215-882-00	METAL OXIDE	22	5%	2W
R534	1-218-720-11	METAL CHIP	15K	0.50%	1/10W	R589	1-247-895-91	CARBON	470K	5%	1/4W
R535	1-218-865-11	METAL CHIP	5.6K	0.50%	1/10W	R590	1-249-429-11	CARBON	10K	5%	1/4W
R536	1-216-833-11	METAL CHIP	10K	5%	1/10W	R591	1-216-363-00	METAL OXIDE	0.33	5%	2W
R537	1-216-855-11	METAL CHIP	680K	5%	1/10W	R592	1-249-441-11	CARBON	100K	5%	1/4W
R539	1-216-864-11	SHORT CHIP				R593	1-249-429-11	CARBON	10K	5%	1/4W
R540	1-249-429-11	CARBON	10K	5%	1/4W	R594	1-249-418-11	CARBON	1.2K	5%	1/4W
R542	1-215-445-00	METAL	10K	1%	1/4W	R595	1-247-895-91	CARBON	470K	5%	1/4W
R543	1-216-368-11	METAL OXIDE	0.82	5%	2W	R596	1-249-377-11	CARBON	0.47	5%	1/4W
R544	1-249-389-11	CARBON	4.7	5%	1/4W	R597	1-216-849-11	METAL CHIP	220K	5%	1/10W
R545	1-215-890-11	METAL OXIDE	470	5%	2W	R598	1-249-377-11	CARBON	0.47	5%	1/4W
R546	1-249-385-11	CARBON	2.2	5%	1/4W	R601	1-240-262-11	CEMENTED	0.68	5%	10W
R547	1-215-445-00	METAL	10K	1%	1/4W			(KV-27FS120/29FA310LN/29FS120LN ONLY)			
R548	1-218-720-11	METAL CHIP	15K	0.50%	1/10W	R601	1-202-968-11	CEMENTED	1.2	5%	10W
R549	1-216-841-11	METAL CHIP	47K	5%	1/10W			(KV-29FS120LS/29FA310LS ONLY)			
R550	1-216-817-11	METAL CHIP	470	5%	1/10W	R602	1-240-262-11	CEMENTED	0.68	5%	10W
R551	1-216-829-11	METAL CHIP	4.7K	5%	1/10W			(KV-27FS120/29FA310LN/29FS120LN ONLY)			
R553	1-216-821-11	METAL CHIP	1K	5%	1/10W	R602	1-202-968-11	CEMENTED	1.2	5%	10W
R554	1-216-827-11	METAL CHIP	3.3K	5%	1/10W			(KV-29FS120LS/29FA310LS ONLY)			
R555	1-216-833-11	METAL CHIP	10K	5%	1/10W	 R603	1-219-513-11	METAL	4.7M	5%	1/2W
R556	1-216-825-11	METAL CHIP	2.2K	5%	1/10W			(KV-27FS120/29FA310LN/29FS120LN ONLY)			
R557	1-216-825-11	METAL CHIP	2.2K	5%	1/10W	R604	1-216-821-11	METAL CHIP	1K	5%	1/10W
R560	1-216-821-11	METAL CHIP	1K	5%	1/10W	R605	1-216-833-11	METAL CHIP	10K	5%	1/10W
R561	1-216-833-11	METAL CHIP	10K	5%	1/10W	R606	1-216-833-11	METAL CHIP	10K	5%	1/10W
R562	1-249-429-11	CARBON	10K	5%	1/4W	R607	1-216-857-11	METAL CHIP	1M	5%	1/10W
R563	1-218-871-11	METAL CHIP	10K	0.50%	1/10W	R608	1-215-924-00	METAL OXIDE	15K	5%	3W
  R564	1-218-730-11	METAL CHIP	39K	0.50%	1/10W	R609	1-202-962-11	CEMENTED	3.3	5%	10W
 R565	1-218-716-11	METAL CHIP	10K	0.50%	1/10W	R611	1-240-262-11	CEMENTED	0.68	5%	10W
 R566	1-215-469-00	METAL	100K	1%	1/4W			(KV-27FS120/29FA310LN/29FS120LN ONLY)			
R567	1-215-927-00	METAL OXIDE	47K	5%	3W	R611	1-202-968-11	CEMENTED	1.2	5%	10W
R568	1-215-399-00	METAL	120	1%	1/4W			(KV-29FS120LS/29FA310LS ONLY)			
R569	1-249-429-11	CARBON	10K	5%	1/4W	R612	1-260-131-11	CEMENTED	470K	5%	1/2W
R570	1-218-716-11	METAL CHIP	10K	0.50%	1/10W			(KV-29FS120LS/29FA310LS ONLY)			
R572	1-216-829-11	METAL CHIP	4.7K	5%	1/10W	R613	1-240-262-11	CEMENTED	0.68	5%	10W
R573	1-216-829-11	METAL CHIP	4.7K	5%	1/10W			(KV-27FS120/29FA310LN/29FS120LN ONLY)			
R574	1-216-833-11	METAL CHIP	10K	5%	1/10W	R613	1-202-968-11	CEMENTED	1.2	5%	10W
R575	1-249-389-11	CARBON	4.7	5%	1/4W			(KV-29FS120LS/29FA310LS ONLY)			
R578	1-249-429-11	CARBON	10K	5%	1/4W	R614	1-216-825-11	METAL CHIP	2.2K	5%	1/10W
R581	1-249-441-11	CARBON	100K	5%	1/4W						

NOTE: The components identified by shading and  mark are critical for safety. Replace only with part number specified.

NOTE: Les composants identifiés par un trame et une  sont critiques pour la sécurité. Ne les remplacer que par une pièce portant le numéro spécifié.





REF. NO.	PART NO.	DESCRIPTION	VALUES	REF. NO.	PART NO.	DESCRIPTION	VALUES
 T585	1-453-310-21	FBT ASSY NX-4521//X4J4		C2777	1-126-963-11	ELECT	4.7µF 20% 50V
 T601	1-435-617-11	TRANSFORMER, LINE FILTER		C2778	1-126-947-11	ELECT	47µF 20% 35V
 T602	1-435-675-11	TRANSFORMER, STANDBY (KV-27FS120/29FA310LN/29FS120LN ONLY)		C3701	1-126-947-11	ELECT	47µF 20% 35V
 T602	1-435-676-11	TRANSFORMER, STANDBY (KV-29FS120LS/29FA310LS ONLY)		C3702	1-136-497-81	FILM	0.1µF 5% 50V
 T603	1-439-898-21	CONVERTER TRANSFORMER (KV-27FS120/29FS120LN/29FS120LS ONLY)		C3703	1-126-947-11	ELECT	47µF 20% 35V
THERMISTOR				C3708	1-136-497-81	FILM	0.1µF 5% 50V
 THP501	1-804-313-11	THERMISTOR, PTC (KV-27FS120/29FA310LN/29FS120LN ONLY)		C3780	1-162-926-11	CERAMIC CHIP	82pF 5% 50V
 THP501	1-803-540-11	THERMISTOR, PTC (KV-29FS120LS/29FA310LS ONLY)		C3781	1-162-926-11	CERAMIC CHIP	82pF 5% 50V
TUNER				C3782	1-162-926-11	CERAMIC CHIP	82pF 5% 50V
 TU101	8-598-593-50	TUNER, FSS BTF-WA421		C3901	1-107-667-11	ELECT	2.2µF 20% 400V
VARISTOR				C3902	1-107-364-11	MYLAR	0.01µF 10% 200V
 VDR600	1-810-974-21	VARISTOR (KV-27FS120/29FA310LN/29FS120LN ONLY)		C3903	1-126-935-11	ELECT	470µF 20% 16V
 VDR600	1-803-967-11	VARISTOR (KV-29FS120LS/29FA310LS ONLY)		C3904	1-130-471-00	MYLAR	0.001µF 5% 50V
CRYSTAL				C3905	1-107-364-11	MYLAR	0.01µF 10% 200V
X001	1-795-006-21	VIBRATOR, CRYSTAL		C3906	1-130-471-00	MYLAR	0.001µF 5% 50V
X301	1-781-377-21	VIBRATOR, CRYSTAL		C3907	1-107-638-11	ELECT	33µF 20% 160V
CONNECTOR				C3908	1-126-935-11	ELECT	470µF 20% 16V
CW BOARD, MOUNTED				C3909	1-104-999-11	MYLAR	0.1µF 5% 200V
4-382-854-11				C3910	1-104-999-11	MYLAR	0.1µF 5% 200V
SCREW (M3X10), P, SW (+)				C3911	1-104-665-11	ELECT	100µF 20% 25V
CAPACITOR				C3912	1-126-935-11	ELECT	470µF 20% 16V
C2751	1-107-652-11	ELECT	10µF 20% 250V	C3913	1-126-933-11	ELECT	100µF 20% 16V
C2752	1-162-114-00	CERAMIC	0.0047µF 2KV	C3914	1-130-491-00	MYLAR	0.047µF 5% 50V
C2753	1-137-528-11	MYLAR	0.1µF 10% 250V	C3915	1-162-970-11	CERAMIC CHIP	0.01µF 10% 25V
C2754	1-102-074-00	CERAMIC	0.001µF 10% 50V	C3930	1-104-655-91	ELECT	470µF 20% 6.3V
C2755	1-107-651-11	ELECT	4.7µF 20% 250V	C3931	1-104-655-91	ELECT	470µF 20% 6.3V
C2774	1-126-960-11	ELECT	1µF 20% 50V	DIODE			
C2775	1-126-935-11	ELECT	470µF 20% 16V	D2701	8-719-108-12	DIODE	RD9.1EW
CONNECTOR				D2754	8-719-901-83	DIODE	1SS83
CN2707				D2755	8-719-901-83	DIODE	1SS83
1-564-506-11				D2756	8-719-901-83	DIODE	1SS83
* CN2752				D2758	8-719-074-25	DIODE	PG104R
1-564-512-11				D3762	8-719-404-50	DIODE	MA111-TX
CN2753				D3763	8-719-404-50	DIODE	MA111-TX
1-785-879-11				D3772	8-719-404-50	DIODE	MA111-TX
* CN2755							
1-695-915-11							
* CN3903							
1-564-506-11							

NOTE: The components identified by shading and \triangle mark are critical for safety. Replace only with part number specified.

NOTE: Les composants identifiés par un triangle et une marque \triangle sont critiques pour la sécurité. Ne les remplacer que par une pièce portant le numéro spécifié.

REF. NO.	PART NO.	DESCRIPTION	VALUES	REF. NO.	PART NO.	DESCRIPTION	VALUES
D3773	8-719-404-50	DIODE	MA111-TX	Q3762	8-729-422-27	TRANSISTOR	2SD601A-Q
D3782	8-719-404-50	DIODE	MA111-TX	Q3763	8-729-422-27	TRANSISTOR	2SD601A-Q
D3783	8-719-404-50	DIODE	MA111-TX	Q3771	8-729-422-27	TRANSISTOR	2SD601A-Q
D3901	8-719-110-86	DIODE	RD39ESB	Q3772	8-729-422-27	TRANSISTOR	2SD601A-Q
D3902	8-719-110-86	DIODE	RD39ESB	Q3773	8-729-422-27	TRANSISTOR	2SD601A-Q
D3903	8-719-991-33	DIODE	1SS133T-77	Q3781	8-729-422-27	TRANSISTOR	2SD601A-Q
D3905	8-719-510-02	DIODE	D1NS4	Q3782	8-729-422-27	TRANSISTOR	2SD601A-Q
D3906	8-719-404-50	DIODE	MA111-TX	Q3783	8-729-422-27	TRANSISTOR	2SD601A-Q
D3907	8-719-404-50	DIODE	MA111-TX	Q3901	8-729-053-87	TRANSISTOR	KTC4370A
D3908	8-719-404-50	DIODE	MA111-TX	Q3902	6-550-247-01	TRANSISTOR	KTA1659A
FERRITE BEAD				Q3903	8-729-422-27	TRANSISTOR	2SD601A-Q
FB3700	1-410-397-21	FERRITE	1.1 μ H	Q3904	8-729-422-27	TRANSISTOR	2SD601A-Q
FB3701	1-410-397-21	FERRITE	1.1 μ H	Q3905	8-729-424-02	TRANSISTOR	2SB709A-QRS-TX
FB3702	1-410-397-21	FERRITE	1.1 μ H	Q3906	8-729-120-28	TRANSISTOR	2SC1623-L5L6
FB3703	1-410-397-21	FERRITE	1.1 μ H	Q3907	8-729-120-28	TRANSISTOR	2SC1623-L5L6
IC				Q3908	8-729-424-02	TRANSISTOR	2SB709A-QRS-TX
IC2751	8-759-562-43	IC	TDA6108JF/N1B	RESISTOR			
IC3701	8-759-803-42	IC	LA6500-FA	R2756	1-260-328-11	CARBON	1K 5% 1/2W
JACK				R2757	1-260-328-11	CARBON	1K 5% 1/2W
\triangle J2751	1-451-544-11	SOCKET, CRT		R2758	1-260-328-11	CARBON	1K 5% 1/2W
CHIP CONDUCTOR				R2760	1-260-087-11	CARBON	100 5% 1/2W
JR3910	1-216-864-11	SHORT CHIP		R2761	1-216-375-00	METAL OXIDE	3.3 5% 2W
COIL				R2762	1-216-375-00	METAL OXIDE	3.3 5% 2W
L2751	1-408-613-31	INDUCTOR	68 μ H	R2763	1-247-807-31	CARBON	100 5% 1/4W
L3710	1-410-387-11	INDUCTOR	33 μ H	R2764	1-247-807-31	CARBON	100 5% 1/4W
L3711	1-410-387-11	INDUCTOR	33 μ H	R2765	1-247-807-31	CARBON	100 5% 1/4W
L3712	1-410-387-11	INDUCTOR	33 μ H	R2766	1-247-807-31	CARBON	100 5% 1/4W
L3901	1-412-528-11	INDUCTOR	18 μ H	R2767	1-247-807-31	CARBON	100 5% 1/4W
TRANSISTOR				R2768	1-247-807-31	CARBON	100 5% 1/4W
Q2772	8-729-422-27	TRANSISTOR	2SD601A-Q	R2770	1-260-132-11	CARBON	560K 5% 1/2W
Q3710	8-729-424-02	TRANSISTOR	2SB709A-QRS-TX	R2785	1-249-399-11	CARBON	33 5% 1/4W
Q3711	8-729-422-27	TRANSISTOR	2SD601A-Q	R2788	1-249-421-11	CARBON	2.2K 5% 1/4W
Q3712	8-729-422-27	TRANSISTOR	2SD601A-Q	R2789	1-249-425-11	CARBON	4.7K 5% 1/4W
Q3761	8-729-422-27	TRANSISTOR	2SD601A-Q	R3700	1-249-433-11	CARBON	22K 5% 1/4W
				R3701	1-216-833-11	METAL CHIP	10K 5% 1/10W
				R3702	1-216-813-11	METAL CHIP	220 5% 1/10W
				R3704	1-249-419-11	CARBON	1.5K 5% 1/4W
				R3705	1-216-833-11	METAL CHIP	10K 5% 1/10W
				R3706	1-249-381-11	CARBON	1 5% 1/4W
				R3707	1-249-383-11	CARBON	1.5 5% 1/4W
				R3710	1-216-821-11	METAL CHIP	1K 5% 1/10W
				R3711	1-218-692-11	METAL CHIP	1K 0.50% 1/10W

NOTE: The components identified by shading and  mark are critical for safety. Replace only with part number specified.

NOTE: Les composants identifiés par un trame et une marque  sont critiques pour la sécurité. Ne les remplacer que par une pièce portant le numéro spécifique.





REF. NO.	PART NO.	DESCRIPTION	VALUES			REF. NO.	PART NO.	DESCRIPTION	VALUES		
COIL						C1643	1-136-165-00	FILM	0.1μF	5%	50V
L1805	1-406-677-11	INDUCTOR	10MH			C1645	1-136-479-11	FILM	0.001μF	5%	100V
TRANSISTOR						C1647	1-126-947-11	ELECT	47μF	20%	35V
Q1810	8-729-043-95	TRANSISTOR	2SC3840(3)			C1648	1-164-143-11	CERAMIC	0.001μF	10%	1KV
RESISTOR						C1649	1-164-143-11	CERAMIC	0.001μF	10%	1KV
R1845	1-249-441-11	CARBON	100K	5%	1/4W	C1650	1-100-120-51	ELECT	1000μF	20%	35V
R1846	1-249-441-11	CARBON	100K	5%	1/4W	C1652	1-137-374-11	MYLAR	0.047μF	5%	50V
R1847	1-249-441-11	CARBON	100K	5%	1/4W	C1669	1-164-625-11	CERAMIC	680pF	10%	500V
R1848	1-215-894-11	METAL OXIDE	2.2K	5%	2W	C1670	1-164-625-11	CERAMIC	680pF	10%	500V
R1849	1-215-923-00	METAL OXIDE	10K	5%	3W	C1672	1-165-953-11	FILM	47000pF	3%	800V
R1850	1-215-923-00	METAL OXIDE	10K	5%	3W	C1680	1-117-228-71	MYLAR	2.2μF	10%	450V
R1851	1-215-922-11	METAL OXIDE	6.8K	5%	3W	C1815	1-129-718-00	FILM	0.022μF	5%	630V
R1852	1-215-922-11	METAL OXIDE	6.8K	5%	3W	C1816	1-102-244-00	CERAMIC	220pF	10%	500V
TRANSFORMER						C1817	1-129-709-91	FILM	0.0039μF	5%	630V
T1801	1-433-533-12	TRANSFORMER, FERRITE (DFT)				C1818	1-164-645-11	CERAMIC	1000pF	10%	500V
CONNECTOR						C1819	1-102-244-00	CERAMIC	220pF	10%	500V
GD (COM) BOARD, MOUNTED						C1820	1-109-954-11	ELECT	0.47μF	20%	160V
(KV-27FA310/29FA310 ONLY)						* CN1600	1-580-843-11	PIN, CONNECTOR (POWER)			
DIODE						D1611	8-719-062-40	DIODE	D4SBL20μF3		
WIRE ASSY, G2 LEAD 180						D1614	8-719-057-52	DIODE	EZ0150AV1		
SCREW (M3X10), P, SW (+)						D1615	8-719-062-40	DIODE	D4SBL20μF3		
CAPACITOR						D1618	8-719-979-64	DIODE	μF4005PKG23		
C1602	1-137-150-11	FILM	0.01μF	5%	100V	D1621	6-500-181-01	DIODE	MA6D50		
C1604	1-164-625-11	CERAMIC	680pF	10%	500V	D1631	6-500-175-01	DIODE	1E3-TB		
C1609	1-164-625-11	CERAMIC	680pF	10%	500V	D1809	8-719-110-41	DIODE	RD15ESB2		
C1616	1-126-943-11	ELECT	2200μF	20%	25V	D1810	8-719-970-87	DIODE	ERA38-06		
C1617	1-123-024-21	ELECT	33μF		160V	D1811	8-719-970-87	DIODE	ERA38-06		
C1620	1-137-150-11	FILM	0.01μF	5%	100V	D1812	8-719-081-93	DIODE	1N4937/23		
C1624	1-107-636-11	ELECT	10μF	20%	160V	FERRITE BEAD					
C1633	1-136-479-11	FILM	0.001μF	5%	100V	FB1602	1-410-397-21	FERRITE	1.1μH		
C1634	1-126-964-11	ELECT	10μF	20%	50V	FB1604	1-410-397-21	FERRITE	1.1μH		
C1635	1-126-963-11	ELECT	4.7μF	20%	50V	FB1609	1-410-397-21	FERRITE	1.1μH		
C1637	1-136-165-00	FILM	0.1μF	5%	50V	FB1616	1-410-397-21	FERRITE	1.1μH		
C1642	1-126-969-11	ELECT	220μF	20%	50V	FB1617	1-410-397-21	FERRITE	1.1μH		

NOTE: The components identified by shading and  mark are critical for safety. Replace only with part number specified.

NOTE: Les composants identifiés par un trame et une marque  sont critiques pour la sécurité. Ne les remplacer que par une pièce portant le numéro spécifique.



REF. NO.	PART NO.	DESCRIPTION	VALUES	REF. NO.	PART NO.	DESCRIPTION	VALUES
IC				R1660	1-249-429-11	CARBON	10K 5% 1/4W
IC1600	6-705-810-01	IC	MCZ3001DB	R1667	1-249-429-11	CARBON	10K 5% 1/4W
IC1601	8-749-012-13	IC	DM-58	R1668	1-249-418-11	CARBON	1.2K 5% 1/4W
COIL				R1670	1-249-429-11	CARBON	10K 5% 1/4W
L1600	1-406-977-21	INDUCTOR	100µH	R1671	1-243-979-71	METAL OXIDE	0.1 5% 2W
L1604	1-412-525-31	INDUCTOR	10µH	R1672	1-243-979-71	METAL OXIDE	0.1 5% 2W
L1608	1-412-529-81	INDUCTOR	22µH	R1845	1-249-441-11	CARBON	100K 5% 1/4W
L1805	1-406-677-11	INDUCTOR	10MH	R1846	1-249-441-11	CARBON	100K 5% 1/4W
PHOTO COUPLER				R1847	1-249-441-11	CARBON	100K 5% 1/4W
PH1602	8-749-924-35	PHOTO COUPLER	ON3171-R	R1848	1-215-894-11	METAL OXIDE	2.2K 5% 2W
IC LINK				R1849	1-215-923-00	METAL OXIDE	10K 5% 3W
PS1401	1-576-337-21	IC LINK	2.7A 50V	R1850	1-215-923-00	METAL OXIDE	10K 5% 3W
TRANSISTOR				R1851	1-215-922-11	METAL OXIDE	6.8K 5% 3W
Q1600	8-729-052-32	TRANSISTOR	IRFIB7N50A-LF31	R1852	1-215-922-11	METAL OXIDE	6.8K 5% 3W
Q1601	8-729-052-32	TRANSISTOR	IRFIB7N50A-LF31	TRANSFORMER			
Q1810	8-729-043-95	TRANSISTOR	2SC3840(3)	 T1604	1-437-606-12	COVERTER TRANSFORMER	
RESISTOR				T1801	1-433-533-12	TRANSFORMER, FERRITE (DFT)	
 R1615	1-202-933-61	FUSIBLE	0.1 10% 1/2W	HR			
R1616	1-249-418-11	CARBON	1.2K 5% 1/4W	* A-1415-629-A HR (VAR) BOARD, MOUNTED			
R1617	1-249-417-11	CARBON	1K 5% 1/4W	(KV-27FA310/29FA310 ONLY)			
R1619	1-249-377-11	CARBON	0.47 5% 1/4W	CAPACITOR			
R1620	1-215-857-71	METAL OXIDE	10 5% 1W	C3001	1-104-665-11	ELECT	100µF 20% 25V
R1625	1-249-413-11	CARBON	470 5% 1/4W	CONNECTOR			
R1626	1-215-443-00	METAL	8.2K 1% 1/4W	* CN3001	1-564-521-11	PLUG, CONNECTOR	6P
R1629	1-245-478-21	METAL	470K 1% 1/4W	DIODE			
R1630	1-245-478-21	METAL	470K 1% 1/4W	D3001	8-719-109-89	DIODE	RD5.6ESB2
R1631	1-215-449-00	METAL	15K 1% 1/4W	D3002	8-719-057-09	DIODE	LNJ801LPDJA
R1632	1-215-397-00	METAL	100 1% 1/4W	IC			
R1640	1-249-417-11	CARBON	1K 5% 1/4W	IC3001	8-742-211-20	HYB IC	SBX3071-71
R1647	1-215-396-00	METAL	91 1% 1/4W				
R1650	1-249-441-11	CARBON	100K 5% 1/4W				
R1651	1-249-441-11	CARBON	100K 5% 1/4W				
R1658	1-249-393-11	CARBON	10 5% 1/4W				
R1659	1-249-393-11	CARBON	10 5% 1/4W				



REF. NO.	PART NO.	DESCRIPTION	VALUES			REF. NO.	PART NO.	DESCRIPTION	VALUES		
RESISTOR						R1009	1-249-421-11	CARBON	2.2K	5%	1/4W
R3001	1-249-417-11	CARBON	1K	5%	1/4W	R1010	1-249-416-11	CARBON	820	5%	1/4W
R3014	1-247-807-31	CARBON	100	5%	1/4W	R1011	1-249-415-11	CARBON	680	5%	1/4W
SWITCH						R1201	1-249-419-11	CARBON	1.5K	5%	1/4W
S3006	1-786-338-12	SWITCH, TACTILE				R1202	1-249-421-11	CARBON	2.2K	5%	1/4W
SWITCH						R1203	1-249-427-11	CARBON	6.8K	5%	1/4W
HS						R1234	1-247-804-11	CARBON	75	5%	1/4W
* A-1415-674-A HS BOARD, MOUNTED (ALL EXCEPT KV-27FA310/29FA310)						R1235	1-249-409-11	CARBON	220	5%	1/4W
CAPACITOR						R1236	1-249-441-11	CARBON	100K	5%	1/4W
C1001	1-104-665-11	ELECT	100µF	20%	25V	R1237	1-249-409-11	CARBON	220	5%	1/4W
C1234	1-126-960-11	ELECT	1µF	20%	50V	R1238	1-249-441-11	CARBON	100K	5%	1/4W
C1235	1-126-960-11	ELECT	1µF	20%	50V	SWITCH					
DIODE						S1001	1-692-431-21	SWITCH, TACTILE			
D1001	8-719-929-15	DIODE	HZS9.1NB2			S1002	1-692-431-21	SWITCH, TACTILE			
D1002	8-719-070-80	DIODE	LNK0120022G			S1003	1-692-431-21	SWITCH, TACTILE			
D1003	8-719-929-15	DIODE	HZS9.1NB2			S1004	1-692-431-21	SWITCH, TACTILE			
D1004	8-719-109-89	DIODE	RD5.6ESB2			S1005	1-692-431-21	SWITCH, TACTILE			
D1005	8-719-109-89	DIODE	RD5.6ESB2			S1006	1-692-431-21	SWITCH, TACTILE			
D1233	8-719-108-12	DIODE	RD9.1EW			S1007	1-762-816-11	SWITCH, TACTILE			
D1235	8-719-108-12	DIODE	RD9.1EW			S1008	1-762-816-11	SWITCH, TACTILE			
D1236	8-719-108-12	DIODE	RD9.1EW			HU					
IC						* A-1415-631-A HU (VAR) BOARD, MOUNTED (KV-27FA310/29FA310 ONLY)					
IC1001	8-742-212-20	HYB IC	SBX3081-71			CAPACITOR					
JACK						C2234	1-137-194-81	FILM	0.47µF	5%	50V
J1231	1-794-048-11	JACK, PIN 3P				C2235	1-137-194-81	FILM	0.47µF	5%	50V
RESISTOR						DIODE					
R1004	1-249-417-11	CARBON	1K	5%	1/4W	D301	8-719-108-12	DIODE	RD9.1EW		
R1007	1-247-807-31	CARBON	100	5%	1/4W	D2235	8-719-108-12	DIODE	RD9.1EW		
R1008	1-249-427-11	CARBON	6.8K	5%	1/4W	D2236	8-719-108-12	DIODE	RD9.1EW		
RESISTOR						D2240	8-719-110-17	DIODE	RD10ESB2		
RESISTOR						D2241	8-719-110-17	DIODE	RD10ESB2		
RESISTOR						JACK					
RESISTOR						J2231	1-794-048-11	JACK, PIN 3P			



REF. NO.	PART NO.	DESCRIPTION	VALUES			REF. NO.	PART NO.	DESCRIPTION	VALUES		
RESISTOR						C2414	1-126-963-11	ELECT	4.7μF	20%	50V
R1001	1-249-427-11	CARBON	6.8K	5%	1/4W	C2415	1-126-967-11	ELECT	47μF	20%	50V
R1002	1-249-421-11	CARBON	2.2K	5%	1/4W	C2416	1-164-172-11	CERAMIC CHIP	0.0056μF	10%	25V
R1003	1-249-419-11	CARBON	1.5K	5%	1/4W	C2417	1-162-968-11	CERAMIC CHIP	0.0047μF	10%	50V
R2008	1-249-427-11	CARBON	6.8K	5%	1/4W	C2418	1-125-891-11	CERAMIC CHIP	0.47μF	10%	10V
R2009	1-249-421-11	CARBON	2.2K	5%	1/4W	C2419	1-127-715-91	CERAMIC CHIP	0.22μF	10%	16V
R2010	1-249-416-11	CARBON	820	5%	1/4W	C2420	1-126-959-11	ELECT	0.47μF	20%	50V
R2011	1-249-415-11	CARBON	680	5%	1/4W	C2421	1-126-959-11	ELECT	0.47μF	20%	50V
R2235	1-249-409-11	CARBON	220	5%	1/4W	C2422	1-127-715-91	CERAMIC CHIP	0.22μF	10%	16V
R2236	1-249-441-11	CARBON	100K	5%	1/4W	C2423	1-165-176-11	CERAMIC CHIP	0.047μF	10%	16V
R2237	1-249-409-11	CARBON	220	5%	1/4W	C2424	1-162-969-11	CERAMIC CHIP	0.0068μF	10%	25V
R2238	1-249-441-11	CARBON	100K	5%	1/4W	C2425	1-107-826-11	CERAMIC CHIP	0.1μF	10%	16V
R2240	1-247-804-11	CARBON	75	5%	1/4W	C2426	1-162-927-11	CERAMIC CHIP	100pF	5%	50V
SWITCH						C2427	1-126-947-11	ELECT	47μF	20%	35V
S1007	1-762-816-11	SWITCH, TACTILE				C2428	1-126-943-11	ELECT	2200μF	20%	25V
S1008	1-762-816-11	SWITCH, TACTILE				C2429	1-107-826-11	CERAMIC CHIP	0.1μF	10%	16V
S2001	1-692-431-21	SWITCH, TACTILE				C2430	1-126-960-11	ELECT	1μF	20%	50V
S2002	1-692-431-21	SWITCH, TACTILE				C2431	1-126-963-11	ELECT	4.7μF	20%	50V
S2003	1-692-431-21	SWITCH, TACTILE				C2432	1-126-963-11	ELECT	4.7μF	20%	50V
S2004	1-692-431-21	SWITCH, TACTILE				C2433	1-127-715-91	CERAMIC CHIP	0.22μF	10%	16V
S2005	1-692-431-21	SWITCH, TACTILE				C2434	1-107-826-11	CERAMIC CHIP	0.1μF	10%	16V
CAPACITOR						C2435	1-107-826-11	CERAMIC CHIP	0.1μF	10%	16V
C2401	1-130-495-00	MYLAR	0.1μF	5%	50V	C2436	1-107-826-11	CERAMIC CHIP	0.1μF	10%	16V
C2402	1-130-495-00	MYLAR	0.1μF	5%	50V	C2437	1-107-826-11	CERAMIC CHIP	0.1μF	10%	16V
C2403	1-126-964-11	ELECT	10μF	20%	50V	C2438	1-164-227-11	CERAMIC CHIP	0.022μF	10%	25V
C2404	1-162-968-11	CERAMIC CHIP	0.0047μF	10%	50V	C2439	1-164-227-11	CERAMIC CHIP	0.022μF	10%	25V
C2405	1-126-965-91	ELECT	22μF	20%	50V	C2440	1-107-826-11	CERAMIC CHIP	0.1μF	10%	16V
C2406	1-126-964-11	ELECT	10μF	20%	50V	C2441	1-115-412-11	CERAMIC CHIP	680pF	5%	25V
C2407	1-126-964-11	ELECT	10μF	20%	50V	C2442	1-165-176-11	CERAMIC CHIP	0.047μF	10%	16V
C2408	1-162-969-11	CERAMIC CHIP	0.0068μF	10%	25V	C2443	1-115-412-11	CERAMIC CHIP	680pF	5%	25V
C2410	1-126-969-11	ELECT	220μF	20%	50V	C2444	1-165-176-11	CERAMIC CHIP	0.047μF	10%	16V
C2411	1-126-965-91	ELECT	22μF	20%	50V	C2445	1-126-965-91	ELECT	22μF	20%	50V
C2412	1-137-194-81	FILM	0.47μF	5%	50V	C2446	1-130-495-00	MYLAR	0.1μF	5%	50V
C2413	1-100-120-51	ELECT	1000μF	20%	35V	C2447	1-130-495-00	MYLAR	0.1μF	5%	50V
						C2448	1-137-190-91	FILM	0.22μF	5%	50V
						C2449	1-165-176-11	CERAMIC CHIP	0.047μF	10%	16V
						C2450	1-126-963-11	ELECT	4.7μF	20%	50V
						C2451	1-162-967-11	CERAMIC CHIP	0.0033μF	10%	50V
						C2452	1-164-677-11	CERAMIC CHIP	0.033μF	10%	16V
						C2453	1-162-968-11	CERAMIC CHIP	0.0047μF	10%	50V
						C2454	1-107-826-11	CERAMIC CHIP	0.1μF	10%	16V
						C2455	1-107-826-11	CERAMIC CHIP	0.1μF	10%	16V
						C2456	1-126-963-11	ELECT	4.7μF	20%	50V
						C2457	1-126-963-11	ELECT	4.7μF	20%	50V



* **A-1410-921-A K BOARD, MOUNTED**
(KV-27FA310/29FA310 ONLY)

4-382-854-11 SCREW (M3X10), P, SW (+)



REF. NO.	PART NO.	DESCRIPTION	VALUES			REF. NO.	PART NO.	DESCRIPTION	VALUES		
C2458	1-126-963-11	ELECT	4.7μF	20%	50V	DIODE					
C2459	1-126-965-91	ELECT	22μF	20%	50V	D2400	8-719-404-50	DIODE	MA111-TX		
C2460	1-137-194-81	FILM	0.47μF	5%	50V	D2401	8-719-070-60	DIODE	PDZ7.5B-115		
C2461	1-126-963-11	ELECT	4.7μF	20%	50V	IC					
C2462	1-126-963-11	ELECT	4.7μF	20%	50V	IC2401	6-705-054-01	IC	TDA8947J		
C2463	1-107-826-11	CERAMIC CHIP	0.1μF	10%	16V	IC2402	8-759-100-96	IC	UPC4558G2		
C2464	1-126-960-11	ELECT	1μF	20%	50V	IC2403	6-706-034-01	IC	NJW1164M-TE2		
C2465	1-107-826-11	CERAMIC CHIP	0.1μF	10%	16V	IC2404	8-759-165-01	IC	NJM2177AFG1		
C2466	1-162-968-11	CERAMIC CHIP	0.0047μF	10%	50V	IC2405	8-759-686-15	IC	NJM2180M (TE2)		
C2467	1-164-677-11	CERAMIC CHIP	0.033μF	10%	16V	CHIP CONDUCTOR					
C2468	1-162-967-11	CERAMIC CHIP	0.0033μF	10%	50V	JR2401	1-216-864-11	SHORT CHIP			
C2469	1-130-495-00	MYLAR	0.1μF	5%	50V	JR2402	1-216-864-11	SHORT CHIP			
C2470	1-162-968-11	CERAMIC CHIP	0.0047μF	10%	50V	JR2410	1-216-864-11	SHORT CHIP			
C2471	1-162-968-11	CERAMIC CHIP	0.0047μF	10%	50V	JR2411	1-216-864-11	SHORT CHIP			
C2472	1-162-970-11	CERAMIC CHIP	0.01μF	10%	25V	JR2420	1-216-864-11	SHORT CHIP			
C2473	1-126-964-11	ELECT	10μF	20%	50V	JR2421	1-216-864-11	SHORT CHIP			
C2474	1-126-964-11	ELECT	10μF	20%	50V	IC LINK					
C2475	1-126-968-11	ELECT	100μF	20%	50V	PS2401	1-576-337-21	IC LINK	2.7A	50V	
C2476	1-162-970-11	CERAMIC CHIP	0.01μF	10%	25V	TRANSISTOR					
C2477	1-107-826-11	CERAMIC CHIP	0.1μF	10%	16V	Q2400	8-729-120-28	TRANSISTOR	2SC1623-L5L6		
C2478	1-162-968-11	CERAMIC CHIP	0.0047μF	10%	50V	Q2401	8-729-120-28	TRANSISTOR	2SC1623-L5L6		
C2479	1-107-826-11	CERAMIC CHIP	0.1μF	10%	16V	Q2410	8-729-424-02	TRANSISTOR	2SB709A-QRS-TX		
C2480	1-107-826-11	CERAMIC CHIP	0.1μF	10%	16V	Q2411	8-729-424-02	TRANSISTOR	2SB709A-QRS-TX		
C2481	1-162-968-11	CERAMIC CHIP	0.0047μF	10%	50V	Q2412	8-729-424-02	TRANSISTOR	2SB709A-QRS-TX		
C2482	1-107-826-11	CERAMIC CHIP	0.1μF	10%	16V	Q2413	8-729-424-02	TRANSISTOR	2SB709A-QRS-TX		
C2484	1-130-495-00	MYLAR	0.1μF	5%	50V	Q2414	8-729-422-27	TRANSISTOR	2SD601A-Q		
C2485	1-130-495-00	MYLAR	0.1μF	5%	50V	Q2418	8-729-120-28	TRANSISTOR	2SC1623-L5L6		
C2486	1-162-970-11	CERAMIC CHIP	0.01μF	10%	25V	Q2419	8-729-120-28	TRANSISTOR	2SC1623-L5L6		
C2487	1-127-715-91	CERAMIC CHIP	0.22μF	10%	16V	RESISTOR					
C2488	1-162-968-11	CERAMIC CHIP	0.0047μF	10%	50V	R2401	1-216-845-11	METAL CHIP	100K	5%	1/10W
C2489	1-127-715-91	CERAMIC CHIP	0.22μF	10%	16V	R2402	1-216-833-11	METAL CHIP	10K	5%	1/10W
C2490	1-104-665-11	ELECT	100μF	20%	25V	R2403	1-216-829-11	METAL CHIP	4.7K	5%	1/10W
C2493	1-126-935-11	ELECT	470μF	20%	16V	R2404	1-216-835-11	METAL CHIP	15K	5%	1/10W
C2494	1-126-935-11	ELECT	470μF	20%	16V	R2405	1-218-895-11	METAL CHIP	100K	0.50%	1/10W
C2495	1-126-935-11	ELECT	470μF	20%	16V	R2406	1-218-714-11	METAL CHIP	8.2K	0.50%	1/10W
C2496	1-126-935-11	ELECT	470μF	20%	16V	R2407	1-216-835-11	METAL CHIP	15K	5%	1/10W
C2499	1-164-315-11	CERAMIC CHIP	470pF	5%	50V						
CONNECTOR											
*	CN2401	1-564-510-11	PLUG, CONNECTOR	7P							
*	CN2402	1-564-508-11	PLUG, CONNECTOR	5P							



REF. NO.	PART NO.	DESCRIPTION	VALUES			REF. NO.	PART NO.	DESCRIPTION	VALUES		
R2408	1-218-868-11	METAL CHIP	7.5K	0.50%	1/10W	R2454	1-216-821-11	METAL CHIP	1K	5%	1/10W
R2409	1-216-833-11	METAL CHIP	10K	5%	1/10W	R2455	1-216-809-11	METAL CHIP	100	5%	1/10W
R2410	1-216-835-11	METAL CHIP	15K	5%	1/10W	R2456	1-216-809-11	METAL CHIP	100	5%	1/10W
R2411	1-216-841-11	METAL CHIP	47K	5%	1/10W	R2457	1-216-864-11	SHORT CHIP			
R2412	1-218-868-11	METAL CHIP	7.5K	0.50%	1/10W	R2458	1-216-861-11	METAL CHIP	2.2M	5%	1/10W
R2413	1-216-841-11	METAL CHIP	47K	5%	1/10W	R2459	1-216-853-11	METAL CHIP	470K	5%	1/10W
R2414	1-216-835-11	METAL CHIP	15K	5%	1/10W	R2460	1-218-714-11	METAL CHIP	8.2K	0.50%	1/10W
R2415	1-220-397-11	METAL CHIP	4.7M	5%	1/10W	R2461	1-216-839-11	METAL CHIP	33K	5%	1/10W
R2416	1-216-837-11	METAL CHIP	22K	5%	1/10W	R2462	1-218-296-11	METAL CHIP	75K	5%	1/10W
R2417	1-216-837-11	METAL CHIP	22K	5%	1/10W	R2463	1-216-823-11	METAL CHIP	1.5K	5%	1/10W
R2418	1-216-809-11	METAL CHIP	100	5%	1/10W	R2464	1-218-331-11	METAL CHIP	51K	5%	1/10W
R2419	1-216-809-11	METAL CHIP	100	5%	1/10W	R2465	1-216-824-11	METAL CHIP	1.8K	5%	1/10W
R2420	1-216-837-11	METAL CHIP	22K	5%	1/10W	R2466	1-218-866-11	METAL CHIP	6.2K	0.50%	1/10W
R2421	1-216-837-11	METAL CHIP	22K	5%	1/10W	R2467	1-216-833-11	METAL CHIP	10K	5%	1/10W
R2422	1-216-833-11	METAL CHIP	10K	5%	1/10W	R2468	1-216-833-11	METAL CHIP	10K	5%	1/10W
R2423	1-216-840-11	METAL CHIP	39K	5%	1/10W	R2469	1-216-833-11	METAL CHIP	10K	5%	1/10W
R2424	1-216-840-11	METAL CHIP	39K	5%	1/10W	R2470	1-216-840-11	METAL CHIP	39K	5%	1/10W
R2425	1-216-840-11	METAL CHIP	39K	5%	1/10W	R2471	1-216-824-11	METAL CHIP	1.8K	5%	1/10W
R2426	1-216-817-11	METAL CHIP	470	5%	1/10W	R2472	1-218-331-11	METAL CHIP	51K	5%	1/10W
R2427	1-216-817-11	METAL CHIP	470	5%	1/10W	R2473	1-216-861-11	METAL CHIP	2.2M	5%	1/10W
R2428	1-216-829-11	METAL CHIP	4.7K	5%	1/10W	R2474	1-216-839-11	METAL CHIP	33K	5%	1/10W
R2429	1-216-829-11	METAL CHIP	4.7K	5%	1/10W	R2475	1-218-296-11	METAL CHIP	75K	5%	1/10W
R2430	1-216-809-11	METAL CHIP	100	5%	1/10W	R2476	1-216-835-11	METAL CHIP	15K	5%	1/10W
R2431	1-216-809-11	METAL CHIP	100	5%	1/10W	R2477	1-216-835-11	METAL CHIP	15K	5%	1/10W
R2432	1-216-864-11	SHORT CHIP				R2478	1-216-845-11	METAL CHIP	100K	5%	1/10W
R2433	1-216-833-11	METAL CHIP	10K	5%	1/10W	R2479	1-216-845-11	METAL CHIP	100K	5%	1/10W
R2434	1-218-895-11	METAL CHIP	100K	0.50%	1/10W	R2480	1-218-331-11	METAL CHIP	51K	5%	1/10W
R2435	1-216-833-11	METAL CHIP	10K	5%	1/10W	R2481	1-216-823-11	METAL CHIP	1.5K	5%	1/10W
R2436	1-216-821-11	METAL CHIP	1K	5%	1/10W	R2482	1-216-833-11	METAL CHIP	10K	5%	1/10W
R2437	1-216-833-11	METAL CHIP	10K	5%	1/10W	R2483	1-216-837-11	METAL CHIP	22K	5%	1/10W
R2438	1-216-833-11	METAL CHIP	10K	5%	1/10W	R2484	1-216-828-11	METAL CHIP	3.9K	5%	1/10W
R2439	1-216-833-11	METAL CHIP	10K	5%	1/10W	R2485	1-216-821-11	METAL CHIP	1K	5%	1/10W
R2440	1-216-837-11	METAL CHIP	22K	5%	1/10W	R2486	1-216-821-11	METAL CHIP	1K	5%	1/10W
R2441	1-216-833-11	METAL CHIP	10K	5%	1/10W	R2487	1-218-717-11	METAL CHIP	11K	0.50%	1/10W
R2442	1-216-821-11	METAL CHIP	1K	5%	1/10W	R2488	1-216-825-11	METAL CHIP	2.2K	5%	1/10W
R2443	1-216-841-11	METAL CHIP	47K	5%	1/10W	R2489	1-216-835-11	METAL CHIP	15K	5%	1/10W
R2446	1-216-833-11	METAL CHIP	10K	5%	1/10W	R2490	1-216-845-11	METAL CHIP	100K	5%	1/10W
R2447	1-216-821-11	METAL CHIP	1K	5%	1/10W	R2491	1-216-845-11	METAL CHIP	100K	5%	1/10W
R2448	1-216-845-11	METAL CHIP	100K	5%	1/10W	R2492	1-216-837-11	METAL CHIP	22K	5%	1/10W
R2449	1-216-841-11	METAL CHIP	47K	5%	1/10W	R2493	1-216-845-11	METAL CHIP	100K	5%	1/10W
R2450	1-216-833-11	METAL CHIP	10K	5%	1/10W	R2494	1-216-845-11	METAL CHIP	100K	5%	1/10W
R2451	1-216-845-11	METAL CHIP	100K	5%	1/10W	R2495	1-218-292-11	METAL CHIP	20K	5%	1/10W
R2452	1-216-821-11	METAL CHIP	1K	5%	1/10W	R2496	1-216-847-11	METAL CHIP	150K	5%	1/10W
R2453	1-216-841-11	METAL CHIP	47K	5%	1/10W	R2497	1-216-823-11	METAL CHIP	1.5K	5%	1/10W



REF. NO.	PART NO.	DESCRIPTION	VALUES			REF. NO.	PART NO.	DESCRIPTION	VALUES																																																																																																																																																																																																																																																		
R2498	1-216-837-11	METAL CHIP	22K	5%	1/10W	DIODE																																																																																																																																																																																																																																																					
R2499	1-216-837-11	METAL CHIP	22K	5%	1/10W	D2801	8-719-109-89	DIODE	RD5.6ESB2																																																																																																																																																																																																																																																		
R2500	1-216-829-11	METAL CHIP	4.7K	5%	1/10W	D2802	8-719-991-33	DIODE	1SS133T-77																																																																																																																																																																																																																																																		
R2501	1-216-837-11	METAL CHIP	22K	5%	1/10W	D2804	8-719-302-43	DIODE	EL1Z																																																																																																																																																																																																																																																		
R2502	1-216-837-11	METAL CHIP	22K	5%	1/10W	D2805	8-719-991-33	DIODE	1SS133T-77																																																																																																																																																																																																																																																		
R2503	1-216-837-11	METAL CHIP	22K	5%	1/10W	D2806	8-719-991-33	DIODE	1SS133T-77																																																																																																																																																																																																																																																		
R2504	1-216-837-11	METAL CHIP	22K	5%	1/10W	D2807	8-719-210-21	DIODE	11EQS04																																																																																																																																																																																																																																																		
R2505	1-216-841-11	METAL CHIP	47K	5%	1/10W	D2808	8-719-991-33	DIODE	1SS133T-77																																																																																																																																																																																																																																																		
R2507	1-216-809-11	METAL CHIP	100	5%	1/10W	D2813	8-719-991-33	DIODE	1SS133T-77																																																																																																																																																																																																																																																		
R2519	1-216-821-11	METAL CHIP	1K	5%	1/10W	IC																																																																																																																																																																																																																																																					
R2520	1-216-821-11	METAL CHIP	1K	5%	1/10W	IC2801	6-701-598-01	IC	UPC5023CS-184																																																																																																																																																																																																																																																		
R2521	1-216-833-11	METAL CHIP	10K	5%	1/10W	COIL																																																																																																																																																																																																																																																					
R2522	1-216-841-11	METAL CHIP	47K	5%	1/10W	L2801	1-406-989-21	INDUCTOR	10MH																																																																																																																																																																																																																																																		
R2523	1-216-841-11	METAL CHIP	47K	5%	1/10W	L2802	1-419-633-11	INDUCTOR	10MH																																																																																																																																																																																																																																																		
R2524	1-216-864-11	SHORT CHIP				L2803	1-412-529-11	INDUCTOR	22μH																																																																																																																																																																																																																																																		
<div style="display: flex; align-items: center;"> <div style="border: 1px solid black; padding: 2px 5px; margin-right: 10px;">V</div> <div> <p>* A-1410-924-A V BOARD, MOUNTED</p> <p>CAPACITOR</p> <table border="0"> <tr> <td>C2801</td> <td>1-128-578-11</td> <td>ELECT</td> <td>1μF</td> <td>20%</td> <td>100V</td> <td>Q2801</td> <td>8-729-422-27</td> <td>TRANSISTOR</td> <td>2SD601A-Q</td> <td></td> <td></td> </tr> <tr> <td>C2802</td> <td>1-126-964-11</td> <td>ELECT</td> <td>10μF</td> <td>20%</td> <td>50V</td> <td>Q2802</td> <td>8-729-424-02</td> <td>TRANSISTOR</td> <td>2SB709A-QRS-TX</td> <td></td> <td></td> </tr> <tr> <td>C2803</td> <td>1-137-378-11</td> <td>MYLAR</td> <td>0.22μF</td> <td>5%</td> <td>50V</td> <td>Q2803</td> <td>8-729-424-02</td> <td>TRANSISTOR</td> <td>2SB709A-QRS-TX</td> <td></td> <td></td> </tr> <tr> <td>C2804</td> <td>1-137-378-11</td> <td>MYLAR</td> <td>0.22μF</td> <td>5%</td> <td>50V</td> <td>Q2804</td> <td>8-729-424-02</td> <td>TRANSISTOR</td> <td>2SB709A-QRS-TX</td> <td></td> <td></td> </tr> <tr> <td>C2805</td> <td>1-129-745-61</td> <td>FILM</td> <td>0.033μF</td> <td>5%</td> <td>400V</td> <td>Q2805</td> <td>6-550-106-01</td> <td>TRANSISTOR</td> <td>KTB764</td> <td></td> <td></td> </tr> <tr> <td>C2808</td> <td>1-162-970-11</td> <td>CERAMIC CHIP</td> <td>0.01μF</td> <td>10%</td> <td>25V</td> <td>Q2807</td> <td>8-729-931-45</td> <td>TRANSISTOR</td> <td>IRF614</td> <td></td> <td></td> </tr> <tr> <td>C2809</td> <td>1-128-934-91</td> <td>CERAMIC CHIP</td> <td>0.33μF</td> <td>20%</td> <td>10V</td> <td>Q2808</td> <td>6-550-106-01</td> <td>TRANSISTOR</td> <td>KTB764</td> <td></td> <td></td> </tr> <tr> <td>C2810</td> <td>1-130-495-00</td> <td>MYLAR</td> <td>0.1μF</td> <td>5%</td> <td>50V</td> <td>Q2812</td> <td>8-729-026-39</td> <td>TRANSISTOR</td> <td>2SA933AS-QT</td> <td></td> <td></td> </tr> <tr> <td>C2811</td> <td>1-129-725-00</td> <td>FILM</td> <td>0.082μF</td> <td>5%</td> <td>400V</td> <td colspan="6">RESISTOR</td> </tr> <tr> <td>C2812</td> <td>1-162-970-11</td> <td>CERAMIC CHIP</td> <td>0.01μF</td> <td>10%</td> <td>25V</td> <td>R2800</td> <td>1-216-837-11</td> <td>METAL CHIP</td> <td>22K</td> <td>5%</td> <td>1/10W</td> </tr> <tr> <td>C2813</td> <td>1-126-933-11</td> <td>ELECT</td> <td>100μF</td> <td>20%</td> <td>16V</td> <td>R2801</td> <td>1-216-841-11</td> <td>METAL CHIP</td> <td>47K</td> <td>5%</td> <td>1/10W</td> </tr> <tr> <td>C2821</td> <td>1-162-970-11</td> <td>CERAMIC CHIP</td> <td>0.01μF</td> <td>10%</td> <td>25V</td> <td>R2802</td> <td>1-216-833-11</td> <td>METAL CHIP</td> <td>10K</td> <td>5%</td> <td>1/10W</td> </tr> <tr> <td>C2823</td> <td>1-130-967-00</td> <td>FILM</td> <td>0.0027μF</td> <td>5%</td> <td>50V</td> <td>R2803</td> <td>1-216-837-11</td> <td>METAL CHIP</td> <td>22K</td> <td>5%</td> <td>1/10W</td> </tr> <tr> <td>C2824</td> <td>1-165-176-11</td> <td>CERAMIC CHIP</td> <td>0.047μF</td> <td>10%</td> <td>16V</td> <td>R2804</td> <td>1-216-833-11</td> <td>METAL CHIP</td> <td>10K</td> <td>5%</td> <td>1/10W</td> </tr> <tr> <td>C2826</td> <td>1-162-927-11</td> <td>CERAMIC CHIP</td> <td>100pF</td> <td>5%</td> <td>50V</td> <td>R2805</td> <td>1-216-829-11</td> <td>METAL CHIP</td> <td>4.7K</td> <td>5%</td> <td>1/10W</td> </tr> <tr> <td>C2862</td> <td>1-126-964-11</td> <td>ELECT</td> <td>10μF</td> <td>20%</td> <td>50V</td> <td>R2807</td> <td>1-216-827-11</td> <td>METAL CHIP</td> <td>3.3K</td> <td>5%</td> <td>1/10W</td> </tr> <tr> <td colspan="12">CONNECTOR</td> </tr> <tr> <td>* CN2901</td> <td>1-564-507-11</td> <td>PLUG, CONNECTOR</td> <td></td> <td></td> <td>4P</td> <td>R2808</td> <td>1-216-833-11</td> <td>METAL CHIP</td> <td>10K</td> <td>5%</td> <td>1/10W</td> </tr> <tr> <td>* CN2902</td> <td>1-770-723-11</td> <td>CONNECTOR, BOARD TO BOARD</td> <td></td> <td></td> <td>8P</td> <td>R2809</td> <td>1-216-837-11</td> <td>METAL CHIP</td> <td>22K</td> <td>5%</td> <td>1/10W</td> </tr> <tr> <td>* CN2903</td> <td>1-564-506-11</td> <td>PLUG, CONNECTOR</td> <td></td> <td></td> <td>3P</td> <td>R2811</td> <td>1-249-393-11</td> <td>CARBON</td> <td>10</td> <td>5%</td> <td>1/4W</td> </tr> </table></div></div>												C2801	1-128-578-11	ELECT	1μF	20%	100V	Q2801	8-729-422-27	TRANSISTOR	2SD601A-Q			C2802	1-126-964-11	ELECT	10μF	20%	50V	Q2802	8-729-424-02	TRANSISTOR	2SB709A-QRS-TX			C2803	1-137-378-11	MYLAR	0.22μF	5%	50V	Q2803	8-729-424-02	TRANSISTOR	2SB709A-QRS-TX			C2804	1-137-378-11	MYLAR	0.22μF	5%	50V	Q2804	8-729-424-02	TRANSISTOR	2SB709A-QRS-TX			C2805	1-129-745-61	FILM	0.033μF	5%	400V	Q2805	6-550-106-01	TRANSISTOR	KTB764			C2808	1-162-970-11	CERAMIC CHIP	0.01μF	10%	25V	Q2807	8-729-931-45	TRANSISTOR	IRF614			C2809	1-128-934-91	CERAMIC CHIP	0.33μF	20%	10V	Q2808	6-550-106-01	TRANSISTOR	KTB764			C2810	1-130-495-00	MYLAR	0.1μF	5%	50V	Q2812	8-729-026-39	TRANSISTOR	2SA933AS-QT			C2811	1-129-725-00	FILM	0.082μF	5%	400V	RESISTOR						C2812	1-162-970-11	CERAMIC CHIP	0.01μF	10%	25V	R2800	1-216-837-11	METAL CHIP	22K	5%	1/10W	C2813	1-126-933-11	ELECT	100μF	20%	16V	R2801	1-216-841-11	METAL CHIP	47K	5%	1/10W	C2821	1-162-970-11	CERAMIC CHIP	0.01μF	10%	25V	R2802	1-216-833-11	METAL CHIP	10K	5%	1/10W	C2823	1-130-967-00	FILM	0.0027μF	5%	50V	R2803	1-216-837-11	METAL CHIP	22K	5%	1/10W	C2824	1-165-176-11	CERAMIC CHIP	0.047μF	10%	16V	R2804	1-216-833-11	METAL CHIP	10K	5%	1/10W	C2826	1-162-927-11	CERAMIC CHIP	100pF	5%	50V	R2805	1-216-829-11	METAL CHIP	4.7K	5%	1/10W	C2862	1-126-964-11	ELECT	10μF	20%	50V	R2807	1-216-827-11	METAL CHIP	3.3K	5%	1/10W	CONNECTOR												* CN2901	1-564-507-11	PLUG, CONNECTOR			4P	R2808	1-216-833-11	METAL CHIP	10K	5%	1/10W	* CN2902	1-770-723-11	CONNECTOR, BOARD TO BOARD			8P	R2809	1-216-837-11	METAL CHIP	22K	5%	1/10W	* CN2903	1-564-506-11	PLUG, CONNECTOR			3P	R2811	1-249-393-11	CARBON	10	5%	1/4W
C2801	1-128-578-11	ELECT	1μF	20%	100V	Q2801	8-729-422-27	TRANSISTOR	2SD601A-Q																																																																																																																																																																																																																																																		
C2802	1-126-964-11	ELECT	10μF	20%	50V	Q2802	8-729-424-02	TRANSISTOR	2SB709A-QRS-TX																																																																																																																																																																																																																																																		
C2803	1-137-378-11	MYLAR	0.22μF	5%	50V	Q2803	8-729-424-02	TRANSISTOR	2SB709A-QRS-TX																																																																																																																																																																																																																																																		
C2804	1-137-378-11	MYLAR	0.22μF	5%	50V	Q2804	8-729-424-02	TRANSISTOR	2SB709A-QRS-TX																																																																																																																																																																																																																																																		
C2805	1-129-745-61	FILM	0.033μF	5%	400V	Q2805	6-550-106-01	TRANSISTOR	KTB764																																																																																																																																																																																																																																																		
C2808	1-162-970-11	CERAMIC CHIP	0.01μF	10%	25V	Q2807	8-729-931-45	TRANSISTOR	IRF614																																																																																																																																																																																																																																																		
C2809	1-128-934-91	CERAMIC CHIP	0.33μF	20%	10V	Q2808	6-550-106-01	TRANSISTOR	KTB764																																																																																																																																																																																																																																																		
C2810	1-130-495-00	MYLAR	0.1μF	5%	50V	Q2812	8-729-026-39	TRANSISTOR	2SA933AS-QT																																																																																																																																																																																																																																																		
C2811	1-129-725-00	FILM	0.082μF	5%	400V	RESISTOR																																																																																																																																																																																																																																																					
C2812	1-162-970-11	CERAMIC CHIP	0.01μF	10%	25V	R2800	1-216-837-11	METAL CHIP	22K	5%	1/10W																																																																																																																																																																																																																																																
C2813	1-126-933-11	ELECT	100μF	20%	16V	R2801	1-216-841-11	METAL CHIP	47K	5%	1/10W																																																																																																																																																																																																																																																
C2821	1-162-970-11	CERAMIC CHIP	0.01μF	10%	25V	R2802	1-216-833-11	METAL CHIP	10K	5%	1/10W																																																																																																																																																																																																																																																
C2823	1-130-967-00	FILM	0.0027μF	5%	50V	R2803	1-216-837-11	METAL CHIP	22K	5%	1/10W																																																																																																																																																																																																																																																
C2824	1-165-176-11	CERAMIC CHIP	0.047μF	10%	16V	R2804	1-216-833-11	METAL CHIP	10K	5%	1/10W																																																																																																																																																																																																																																																
C2826	1-162-927-11	CERAMIC CHIP	100pF	5%	50V	R2805	1-216-829-11	METAL CHIP	4.7K	5%	1/10W																																																																																																																																																																																																																																																
C2862	1-126-964-11	ELECT	10μF	20%	50V	R2807	1-216-827-11	METAL CHIP	3.3K	5%	1/10W																																																																																																																																																																																																																																																
CONNECTOR																																																																																																																																																																																																																																																											
* CN2901	1-564-507-11	PLUG, CONNECTOR			4P	R2808	1-216-833-11	METAL CHIP	10K	5%	1/10W																																																																																																																																																																																																																																																
* CN2902	1-770-723-11	CONNECTOR, BOARD TO BOARD			8P	R2809	1-216-837-11	METAL CHIP	22K	5%	1/10W																																																																																																																																																																																																																																																
* CN2903	1-564-506-11	PLUG, CONNECTOR			3P	R2811	1-249-393-11	CARBON	10	5%	1/4W																																																																																																																																																																																																																																																



REF. NO.	PART NO.	DESCRIPTION	VALUES	REF. NO.	PART NO.	DESCRIPTION	VALUES
R2815	1-215-862-11	METAL OXIDE	68 5% 1W				
R2817	1-218-736-11	METAL CHIP	68K 0.50% 1/10W				
R2818	1-216-809-11	METAL CHIP	100 5% 1/10W	*	4-041-259-05	BAG, PROTECTION	
R2819	1-216-841-11	METAL CHIP	47K 5% 1/10W	*	2-190-595-01	CARTON, INDIVIDUAL (KV-27FA310 ONLY)	
R2820	1-218-883-11	METAL CHIP	33K 0.50% 1/10W	*	4-102-073-01	CARTON, INDIVIDUAL (KV-/29FA310 ONLY)	
R2821	1-218-714-11	METAL CHIP	8.2K 0.50% 1/10W	*	4-103-469-01	CARTON, INDIVIDUAL (KV-27FS120 ONLY)	
R2824	1-218-740-11	METAL CHIP	100K 0.50% 1/10W	*	4-103-471-01	CARTON, INDIVIDUAL (KV-29FS120 ONLY)	
R2825	1-216-845-11	METAL CHIP	100K 5% 1/10W				
R2826	1-249-421-11	CARBON	2.2K 5% 1/4W				
R2827	1-218-708-11	METAL CHIP	4.7K 0.50% 1/10W				
R2828	1-218-728-11	METAL CHIP	33K 0.50% 1/10W	*	4-088-874-01	CUSHION, LOWER (KV-27FS120/29FS120 ONLY)	
R2829	1-216-853-11	METAL CHIP	470K 5% 1/10W	*	4-102-075-01	CUSHION, LOWER (KV-27FA310/29FA310 ONLY)	
R2833	1-218-710-11	METAL CHIP	5.6K 0.50% 1/10W				
R2834	1-218-704-11	METAL CHIP	3.3K 0.50% 1/10W				
R2837	1-218-871-11	METAL CHIP	10K 0.50% 1/10W	*	4-088-875-01	CUSHION, UPPER (KV-27FS120/29FS120 ONLY)	
R2840	1-218-702-11	METAL CHIP	2.7K 0.50% 1/10W	*	4-102-074-01	CUSHION, UPPER (KV-27FA310/29FA310 ONLY)	
R2841	1-218-706-11	METAL CHIP	3.9K 0.50% 1/10W	*	4-093-139-11	INSERT, DOOR BREAKAGE (L) (KV-27FA310 ONLY)	
R2842	1-218-700-11	METAL CHIP	2.2K 0.50% 1/10W				
R2855	1-218-706-11	METAL CHIP	3.9K 0.50% 1/10W				
R2856	1-218-871-11	METAL CHIP	10K 0.50% 1/10W				
R2857	1-218-875-11	METAL CHIP	15K 0.50% 1/10W				
R2860	1-218-716-11	METAL CHIP	10K 0.50% 1/10W		4-101-451-41	MANUAL, INSTRUCTION (KV-27FA310/29FA310 ONLY)	
R2864	1-218-668-11	METAL CHIP	100 0.50% 1/10W		4-101-456-21	MANUAL, INSTRUCTION (KV-27FS120/27FA310 ONLY)	
R2866	1-249-438-11	CARBON	56K 5% 1/4W		4-101-456-31	MANUAL, INSTRUCTION (KV-27FS120/27FA310 CANADA ONLY)	
R2870	1-216-825-11	METAL CHIP	2.2K 5% 1/10W		4-101-456-41	MANUAL, INSTRUCTION (KV-29FS120LN/29FS120LS ONLY)	
R2876	1-216-821-11	METAL CHIP	1K 5% 1/10W				
R2890	1-218-728-11	METAL CHIP	33K 0.50% 1/10W				
R2893	1-216-839-11	METAL CHIP	33K 5% 1/10W				
<u>ACCESSORIES AND PACKING</u>							
<u>REMOTE COMMANDER</u>							
1-476-680-21 REMOTE COMMANDER (RM-Y180) (KV-27FA310/29FA310 ONLY)							
1-478-707-11 REMOTE COMMANDER (RM-Y195) (KV-27FS120/29FS120LN/29FS120LS ONLY)							
4-978-977-11 BATTERY COVER (FOR RM-Y180/Y195)							

Sony Corporation
Sony Technology Center
Technical Services
Service Promotion Department

English
2004CJ74WEB-1
Printed in USA
© 2004.3

In an effort to reduce the size of this pdf file the tiled schematics are not attached to this Service Manual. To receive a complete set of the tiled schematics for this manual please submit a request to:

Service_Promotion@am.sony.com.